

Colección Muisca

Proyecto Sello de Calidad Hecho a Mano

Propuesta de Diseño

Cerámica Tradicional Popular y Contemporánea

Diego Añez Yepes

Ráquira 2008- 2009

Colombia

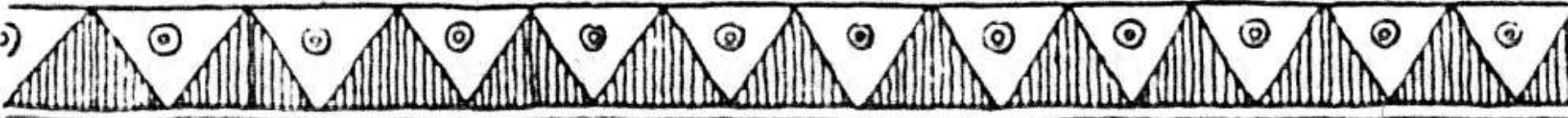

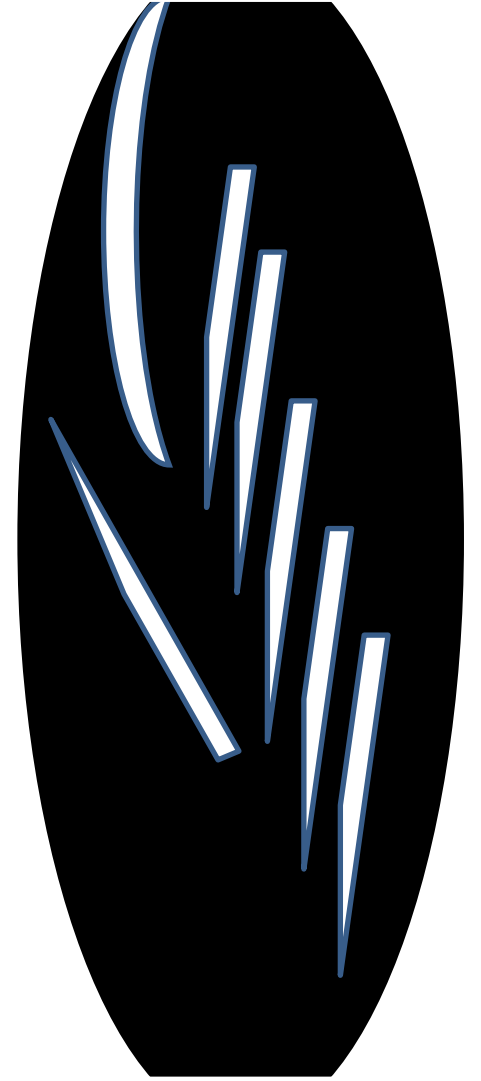
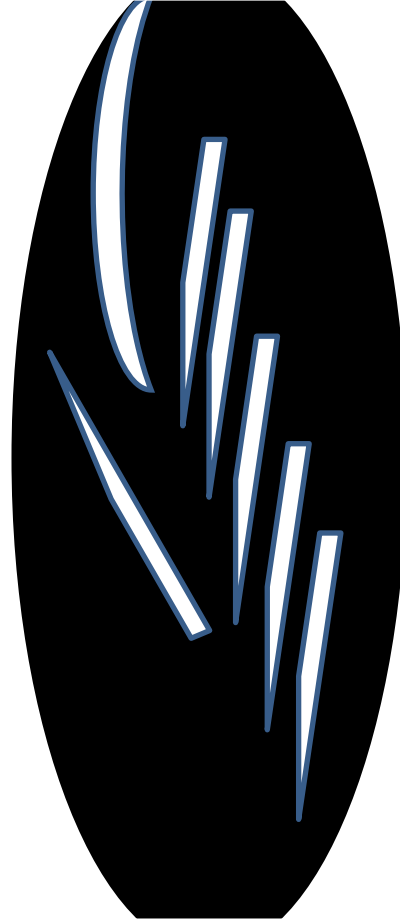
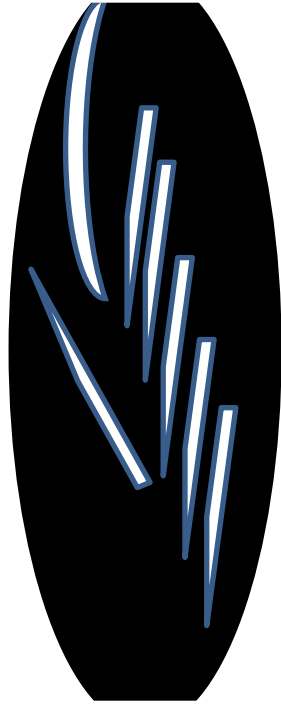

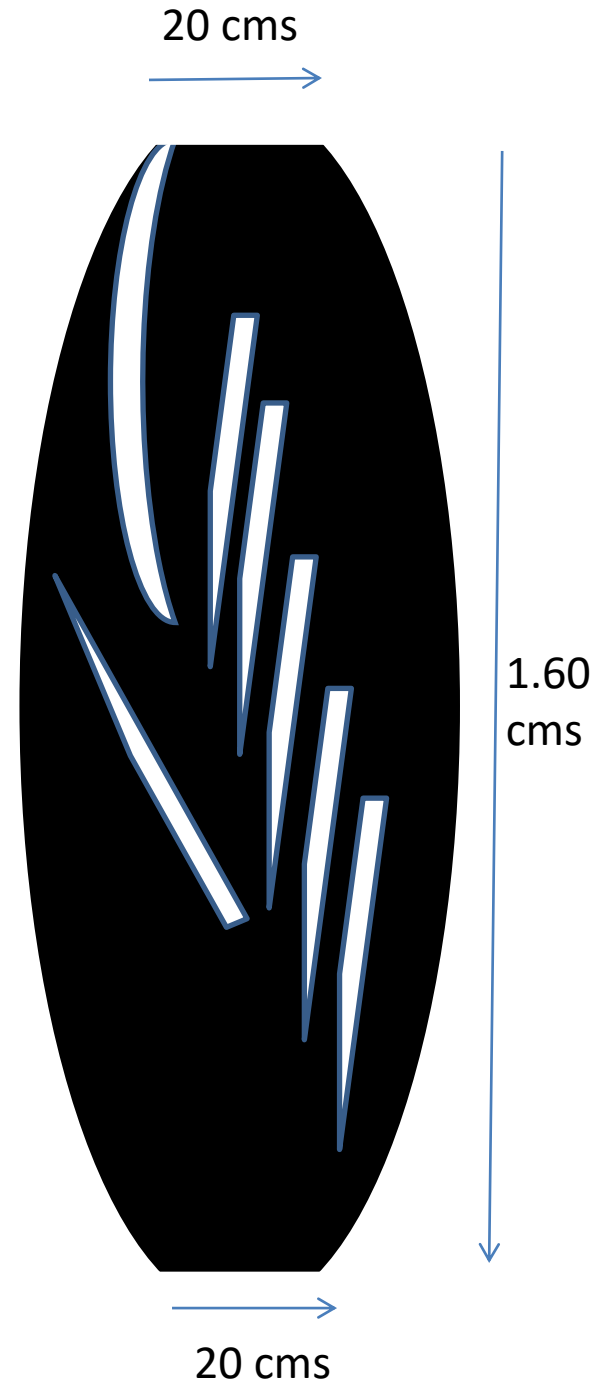
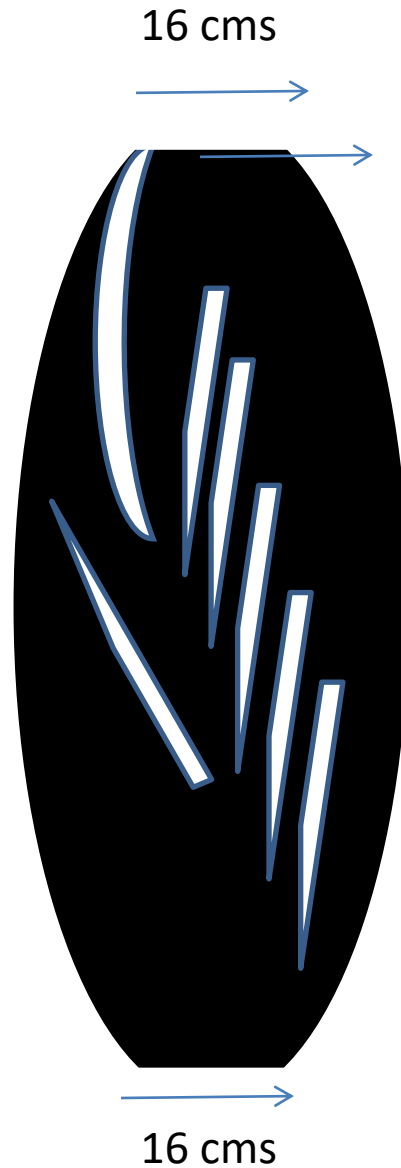
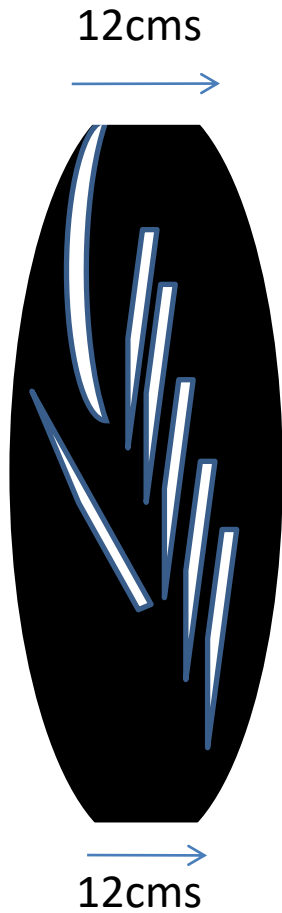

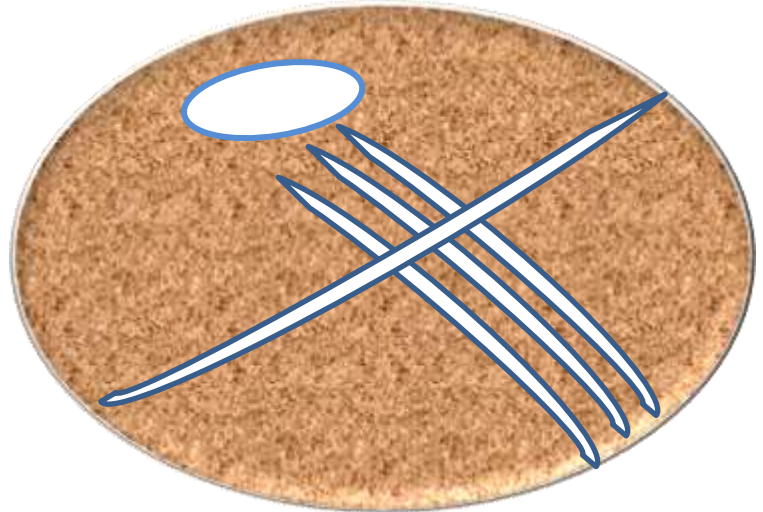
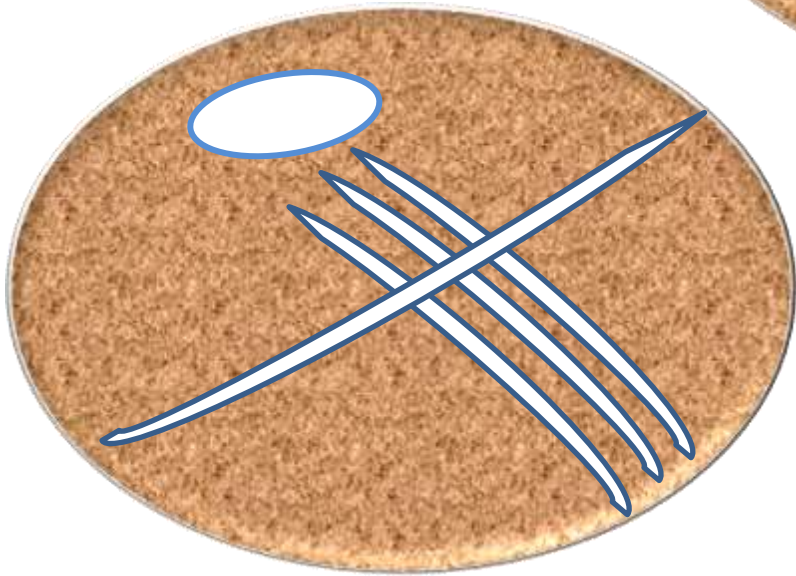
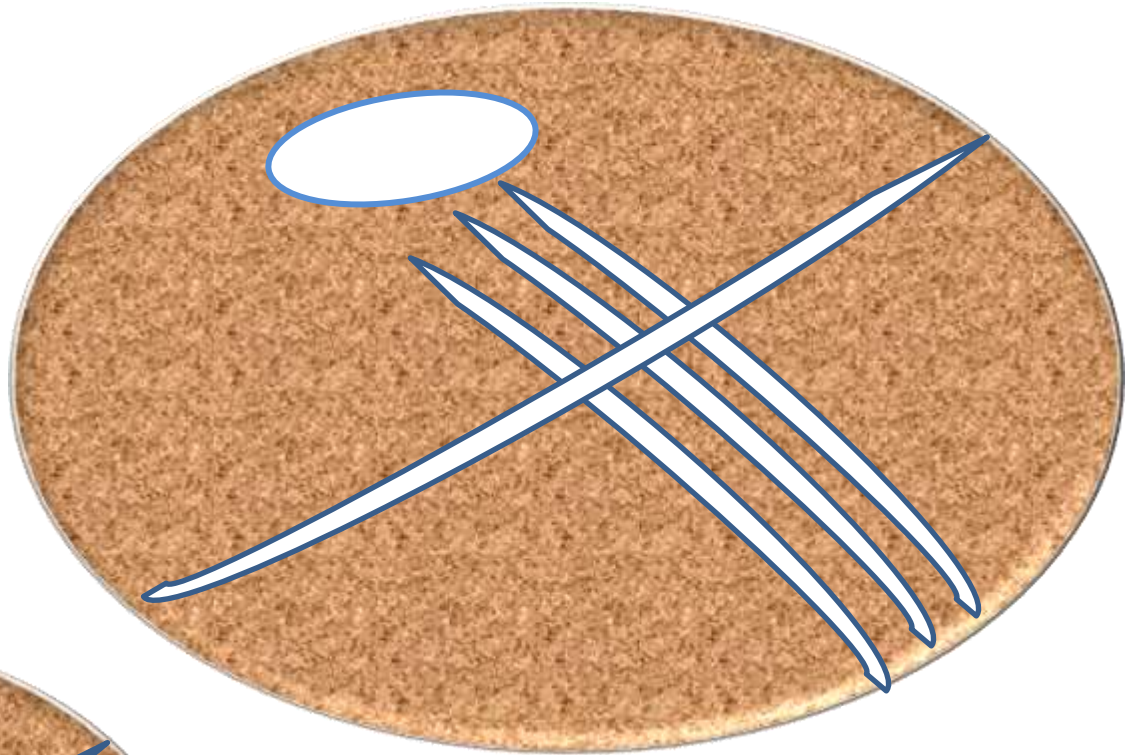

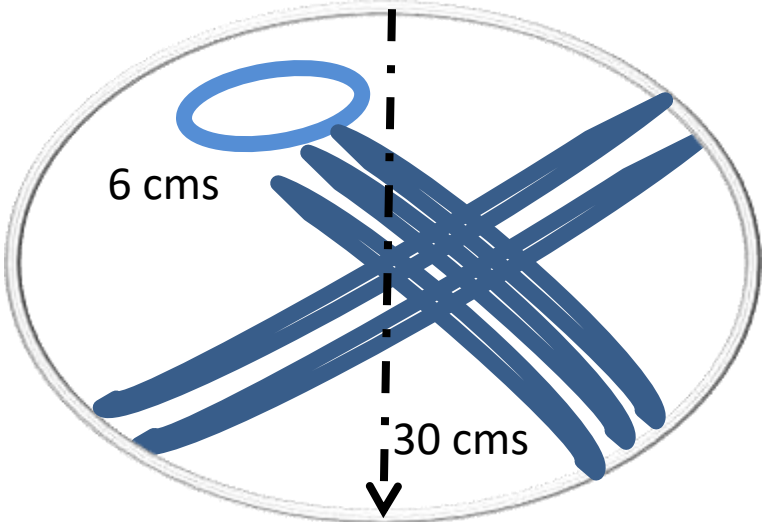
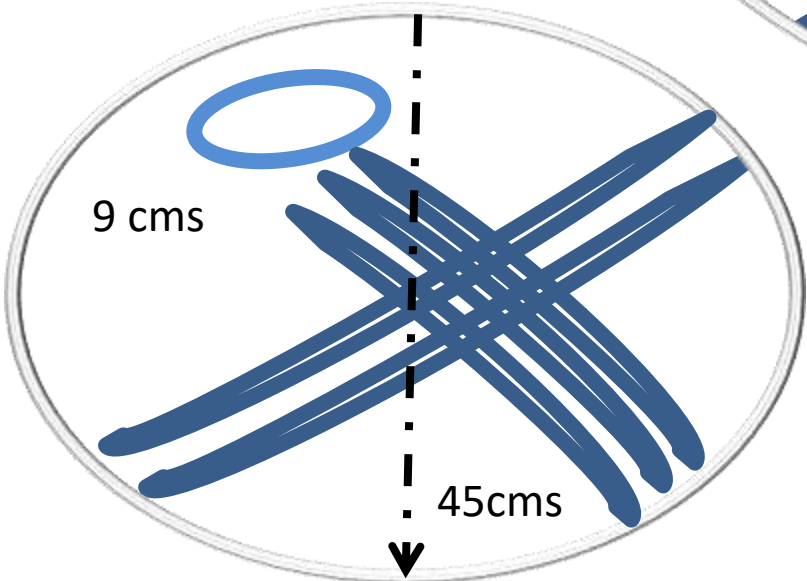
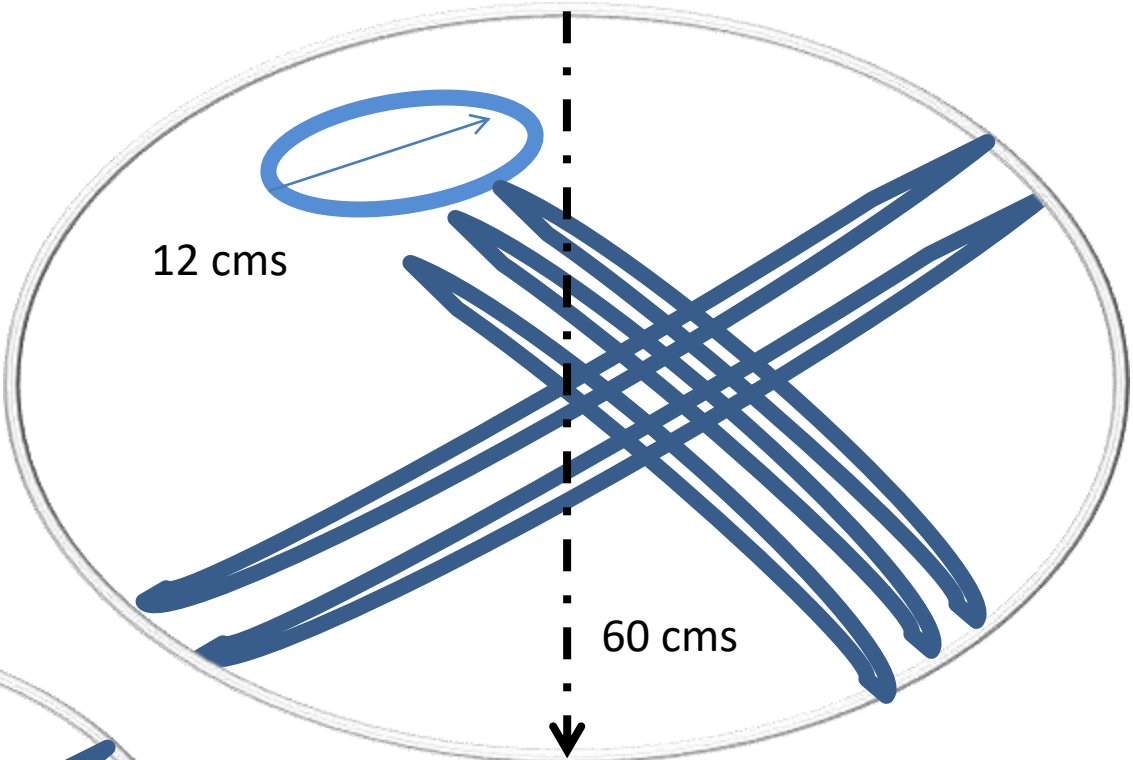

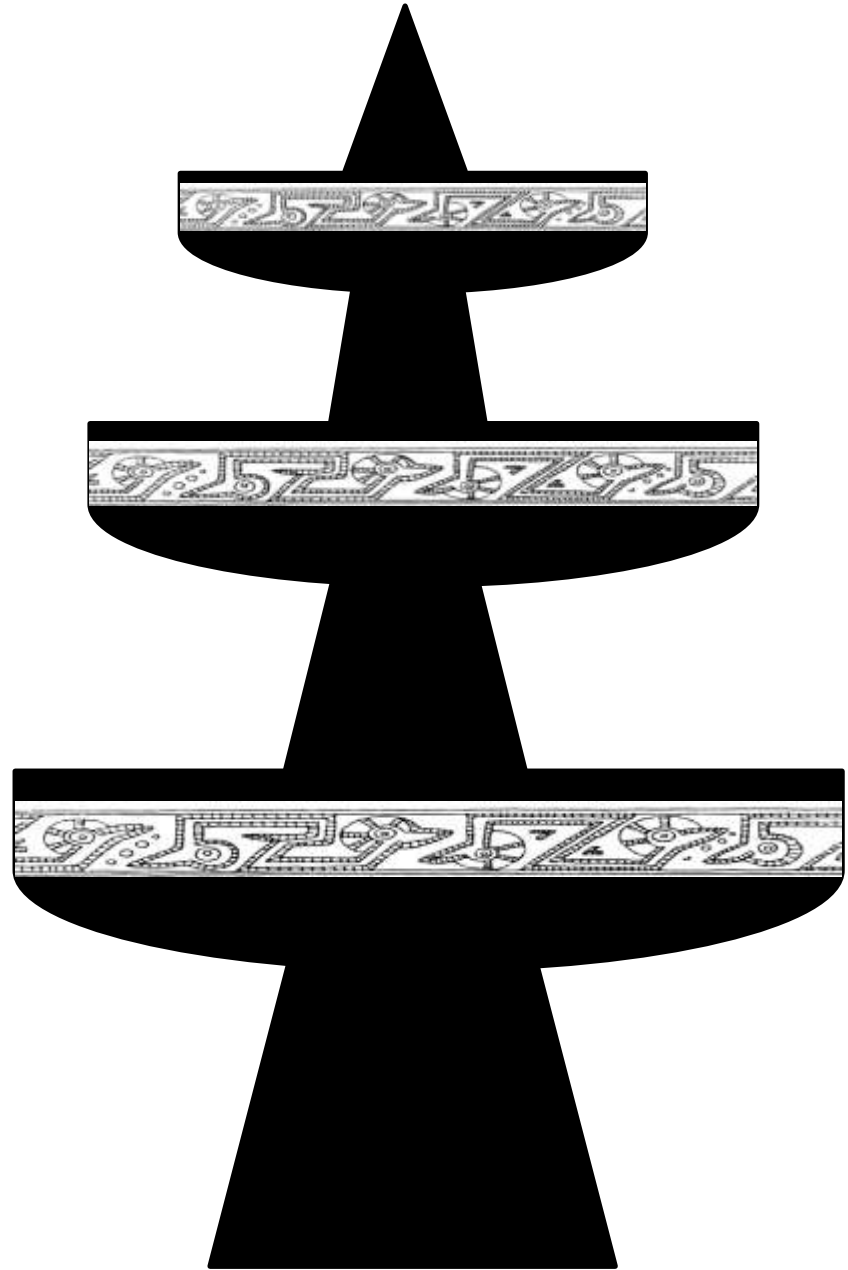
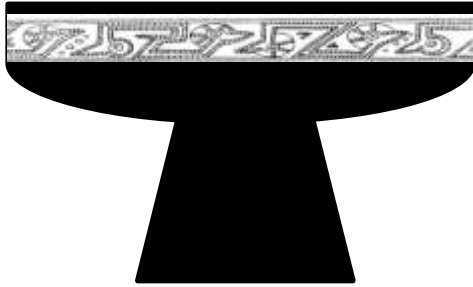

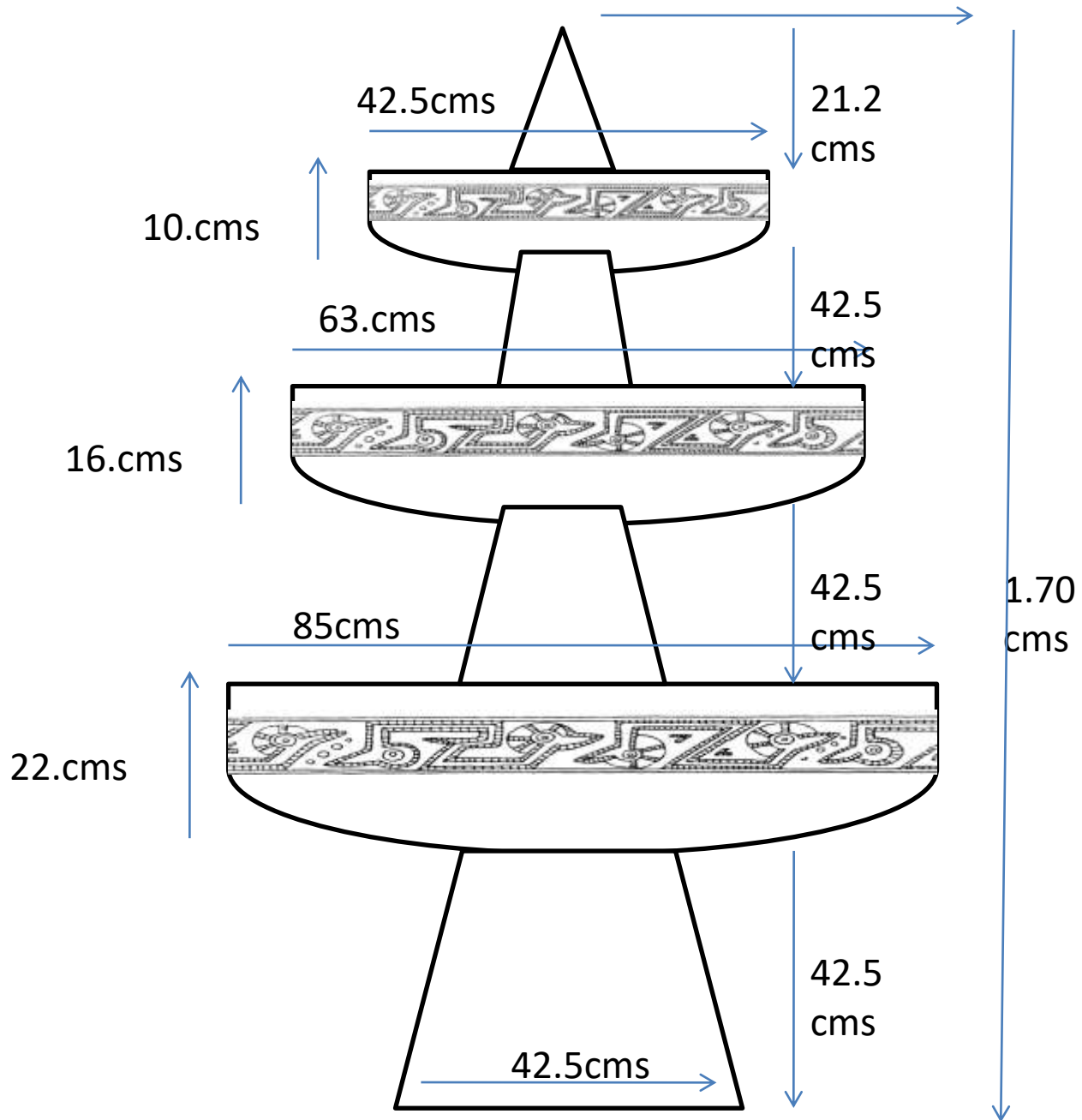



51





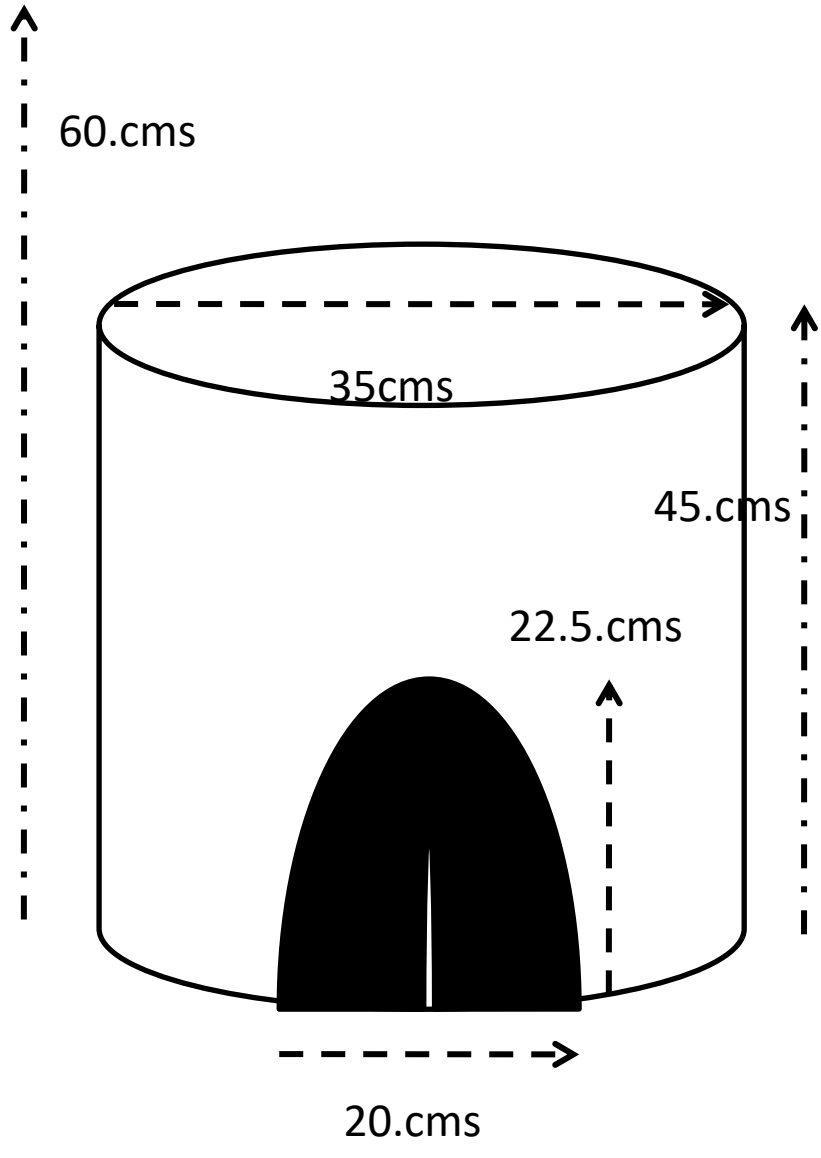
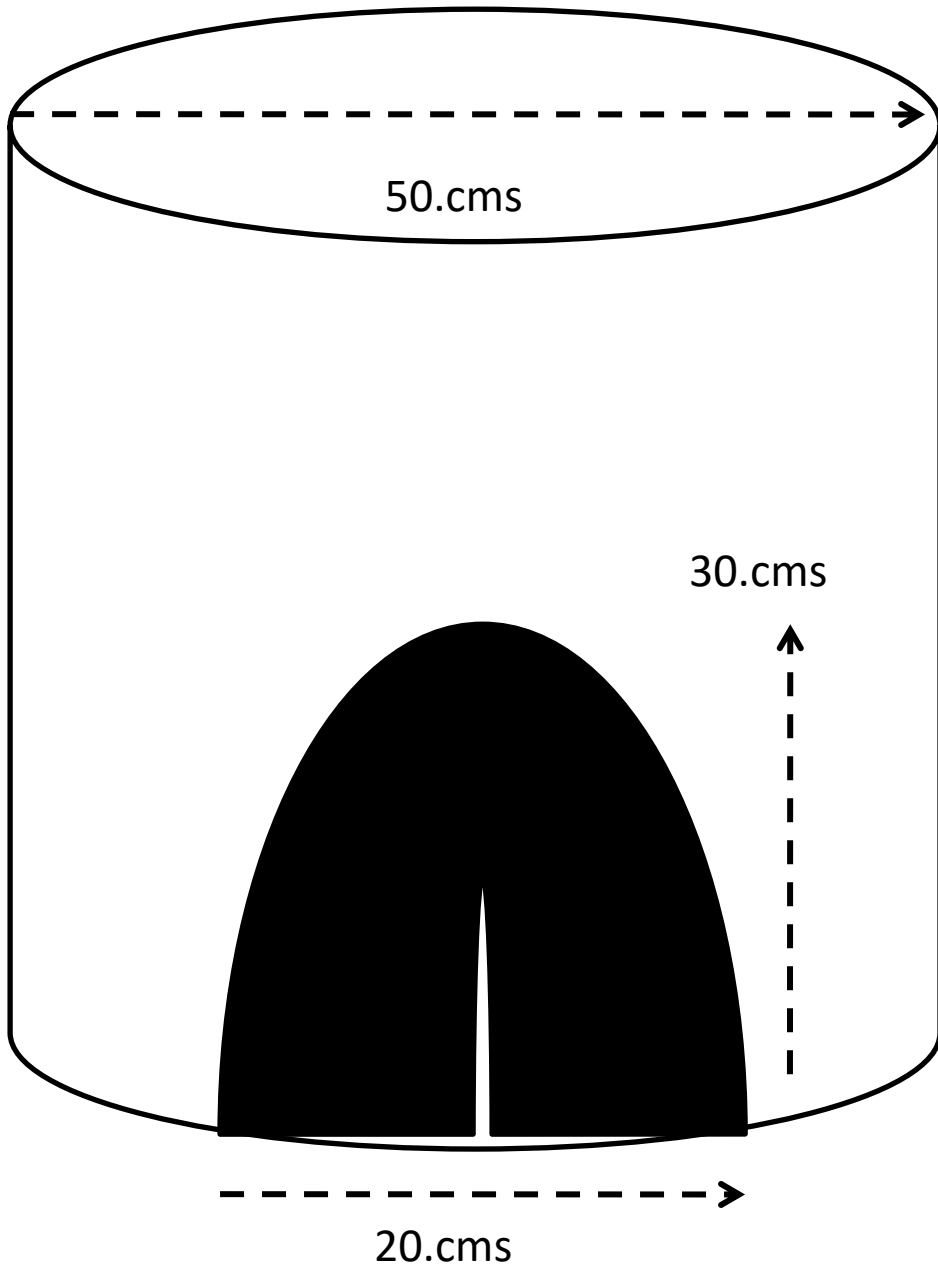



54

55



