



artesanías de colombia

**Ministerio de Desarrollo Económico
Artesanías de Colombia S.A.
OFICINA DE DISEÑO**

**CUADERNO DE DISEÑO-PRODUCCIÓN DE LAS ASESORIAS
REALIZADAS EN EL MUNICIPIO DE SOMONDOCO,
DEPARTAMENTO DE BOYACA**

Anexo

Fichas de planos técnicos

**BEATRIZ UJUETA GUERRA
DISEÑADORA INDUSTRIAL**

**SUBGERENCIA DE DESARROLLO DE ARTESANIAS DE
COLOMBIA S.A. Y ALCALDIA DE SOMONDOCO**

Santafé de Bogotá D. C., Noviembre de 2001

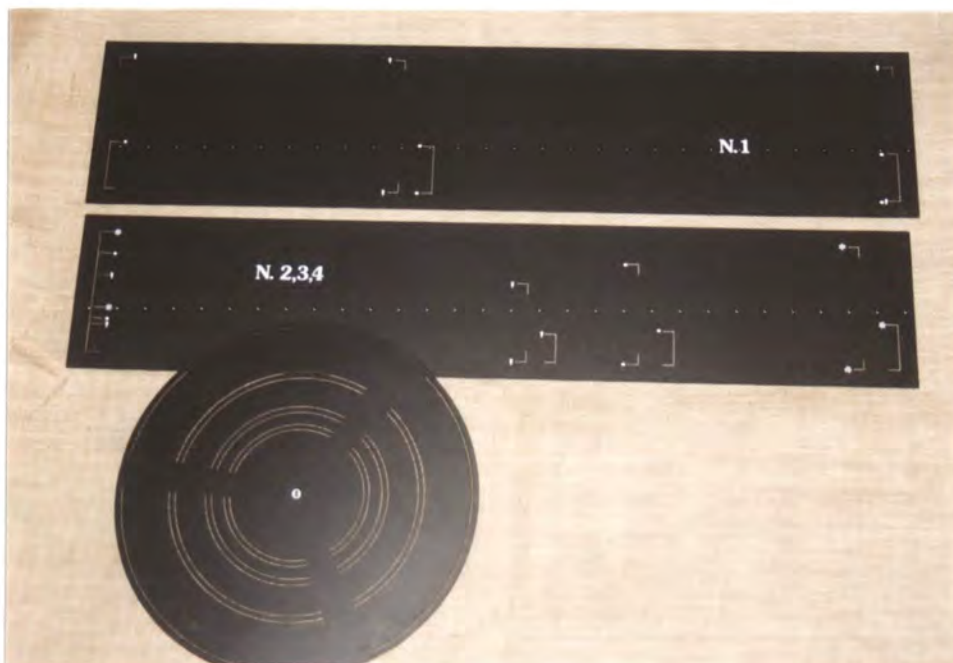

TEMA: <i>Juego de Moldes</i>	LINEA:	ARTESANO: "La Esperanza"
TÍTULO: <i>MBRE:</i>	REFERENCIA:	DEPARTAMENTO: BOYACA
DESCRIPCIÓN: <i>Tejeduría en Calceta</i>	LARGO(cm): ANCHO(cm): ALTO(cm):	MUNICIPIO: SOMONDOCO
TÉCNICA: <i>Tejeduría Calceta de Plátano</i>	DIAMETRO(cm): PESO(gr):	VEREDA/LOCALIDAD: Cabecera Municipal
CURSO NAT: <i>Calceta de Plátano</i>	COLOR: Natural	
MATERIA PRIMA: <i>Amero</i>	CERTIFICADO HECHO A MANO: SI <input type="checkbox"/> NO <input checked="" type="checkbox"/>	

COMERCIO OBJETIVO: <i>Seg. Clase Media y Alta</i>	COSTO:	PRECIO: 175,230
PRODUCCIÓN/MES:	UNITARIO:	UNITARIO:
EMPAQUE:	P.MAYOR:	P.MAYOR:
EMBALAJE:	EMPAQUE:	EMPAQUE:

OBSERVACIONES: *Producido por Teclaser. Material Fleje de 0.6mm. Juego de regletas para la producción de cajas de las artesanas de "La Esperanza".*

ALCALDIA MUNICIPIO DE SOMONDOCO

RESPONSABLE: BEATRIZ UJUETA D. I. FECHA: NOVIEMBRE DE 2001

SISTEMA DE REFERENCIA: 1 5 2 0

TIPO DE FICHA: REFERENTE MUESTRA LINEA EMPAQUE

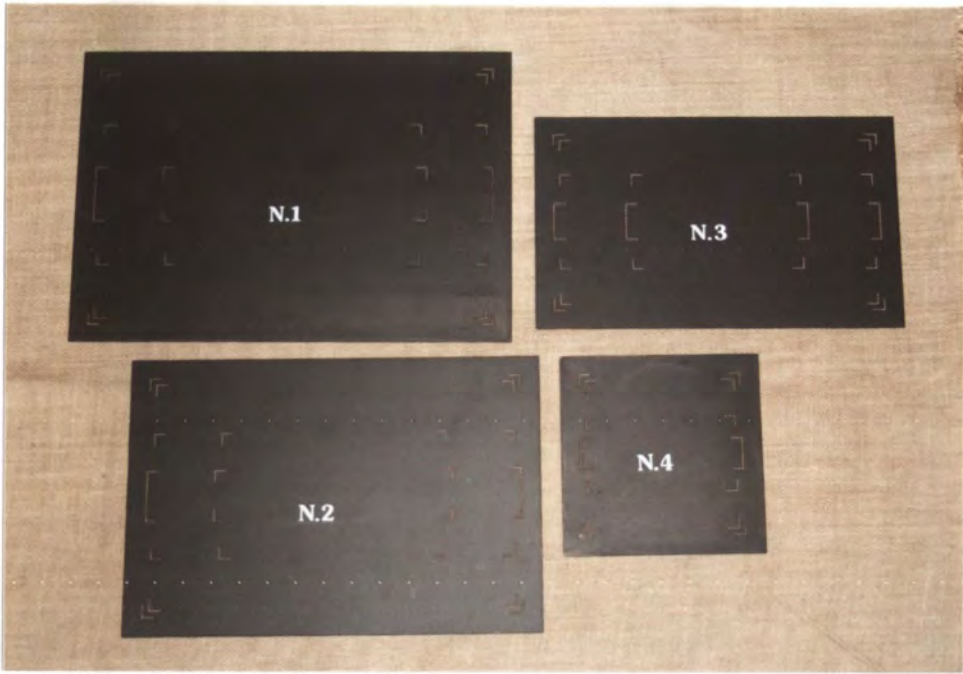

MOLDES PARA CARTON CRAFT

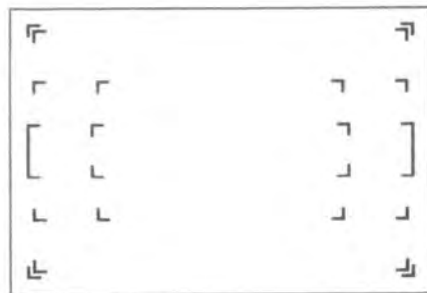
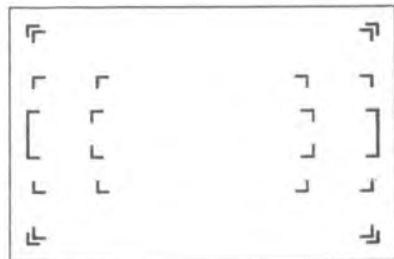
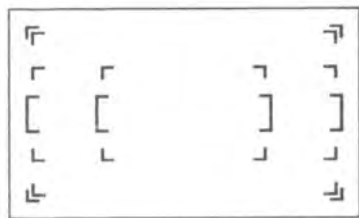
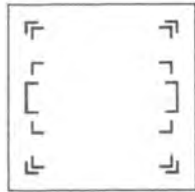

MOLDES PARA CARTON
CARTULINA

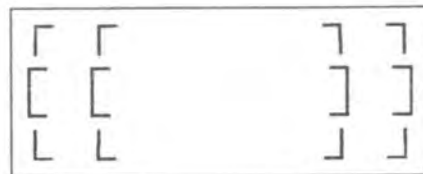
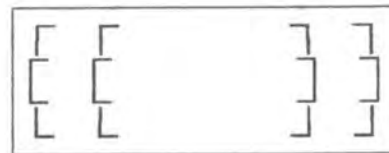
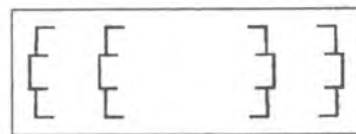

MOLDE PARA EXTERIORES

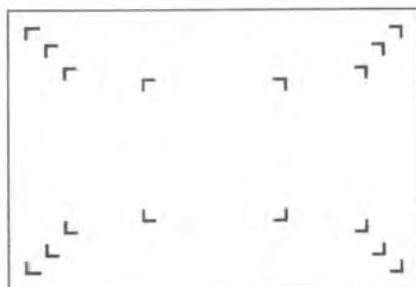

DISEÑO DE MOLDES
PARA EL JUEGO DE
CAJAS
RECTANGULARES
ENTRETEJIDAS
"LA ESPERANZA"

caja Rectangular No. 1

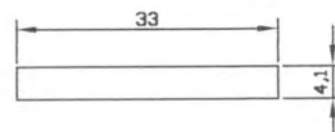
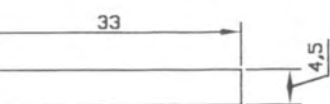
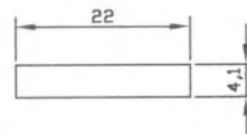
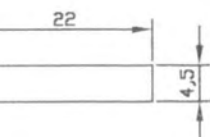
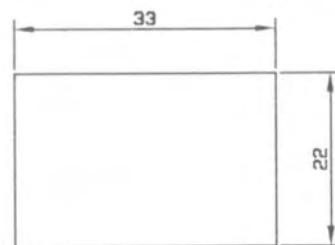
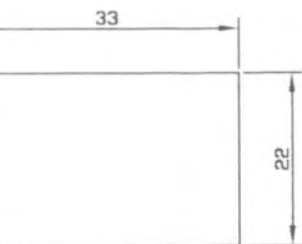
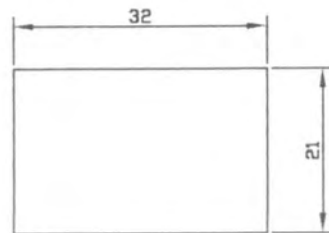
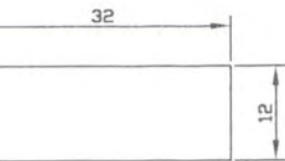
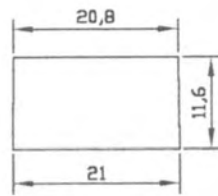
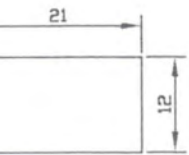
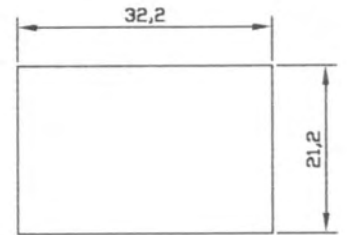
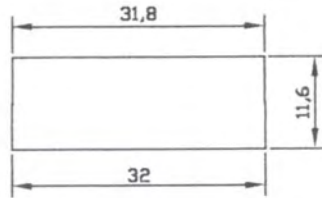
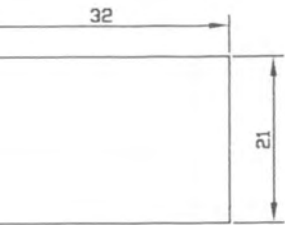

Caja Rectangular No. 2

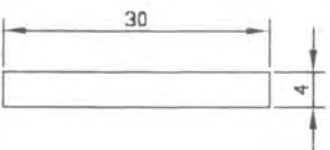
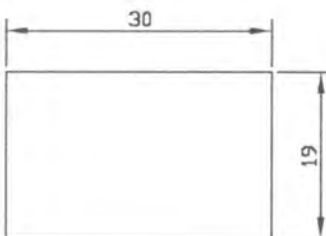
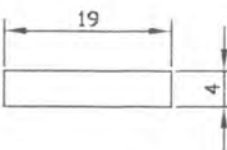
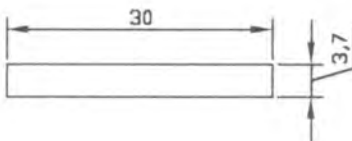
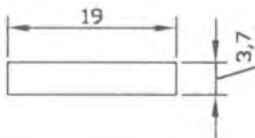
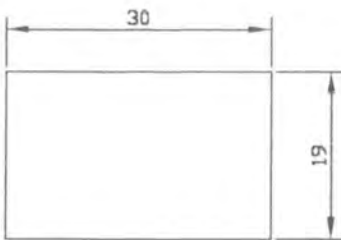
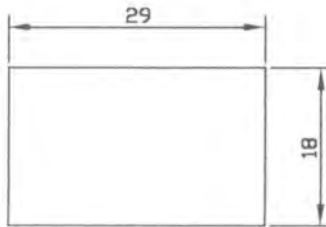
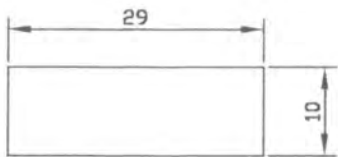
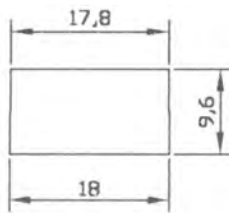
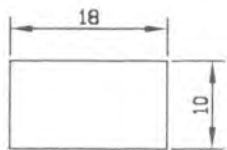
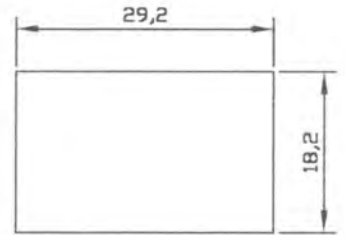
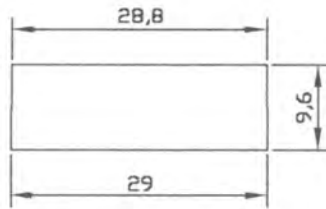
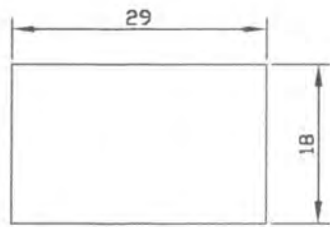

Caja Rectangular No. 3

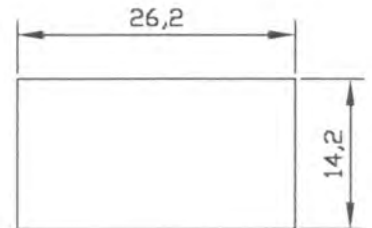
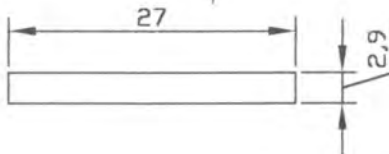
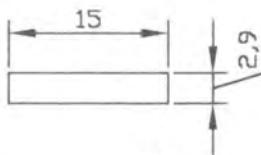
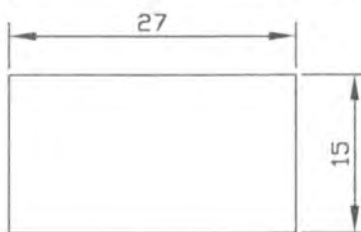
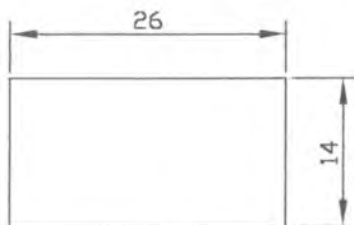
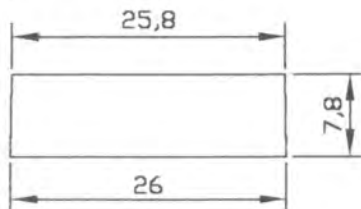
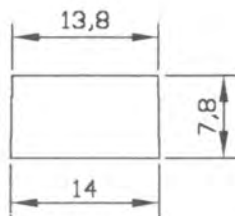
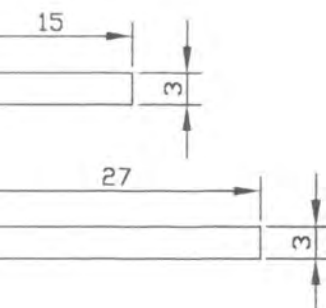
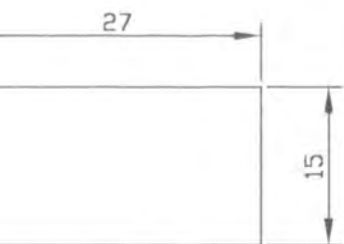
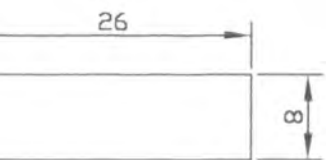
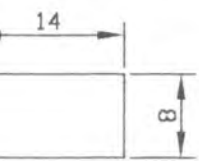
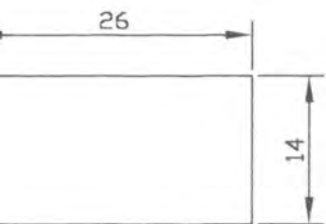

Caja Cuadrada No. 4

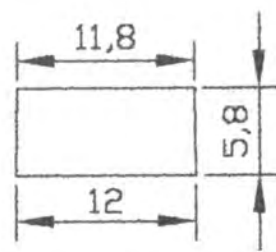
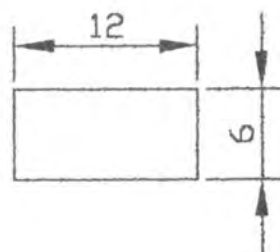
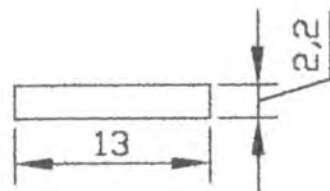
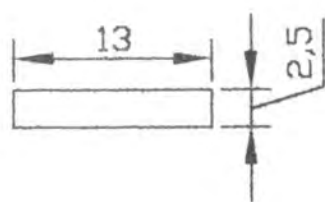
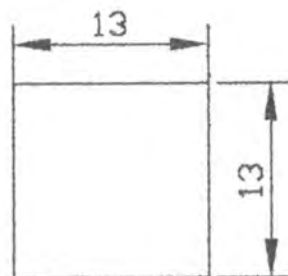
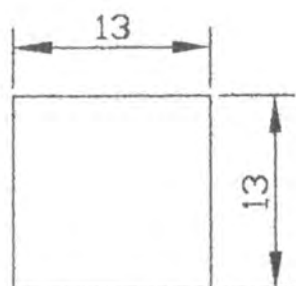
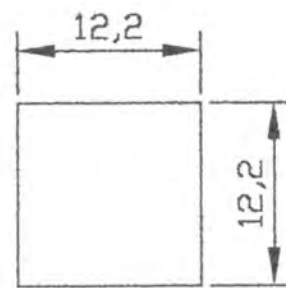
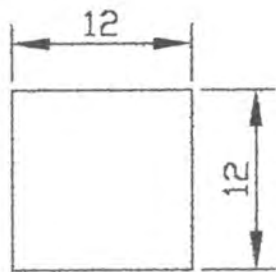
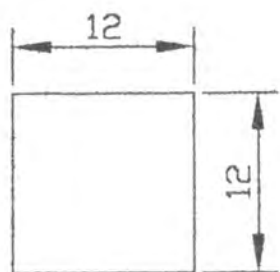



MOLDE PARA CARTON
CRAFT

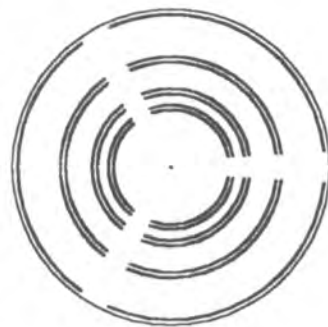

MOLDE PARA CARTON
CARTULINA

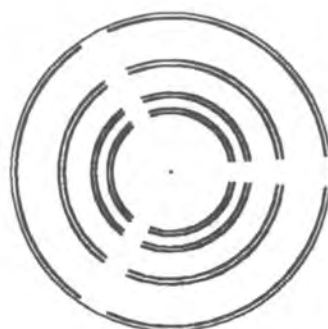

MOLDE PARA EXTERIORES

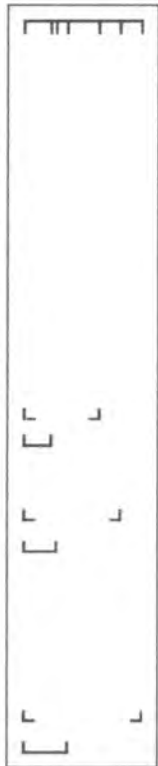

REALETAS PARA LATERALES

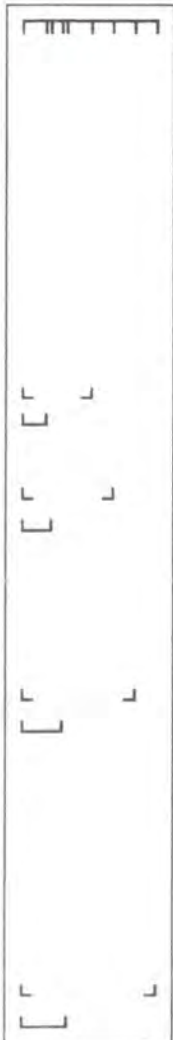

DISEÑO DE MOLDES PARA EL JUEGO
DE CAJAS REDONDAS ENTRETEJIDAS

Caja Redonda No. 4

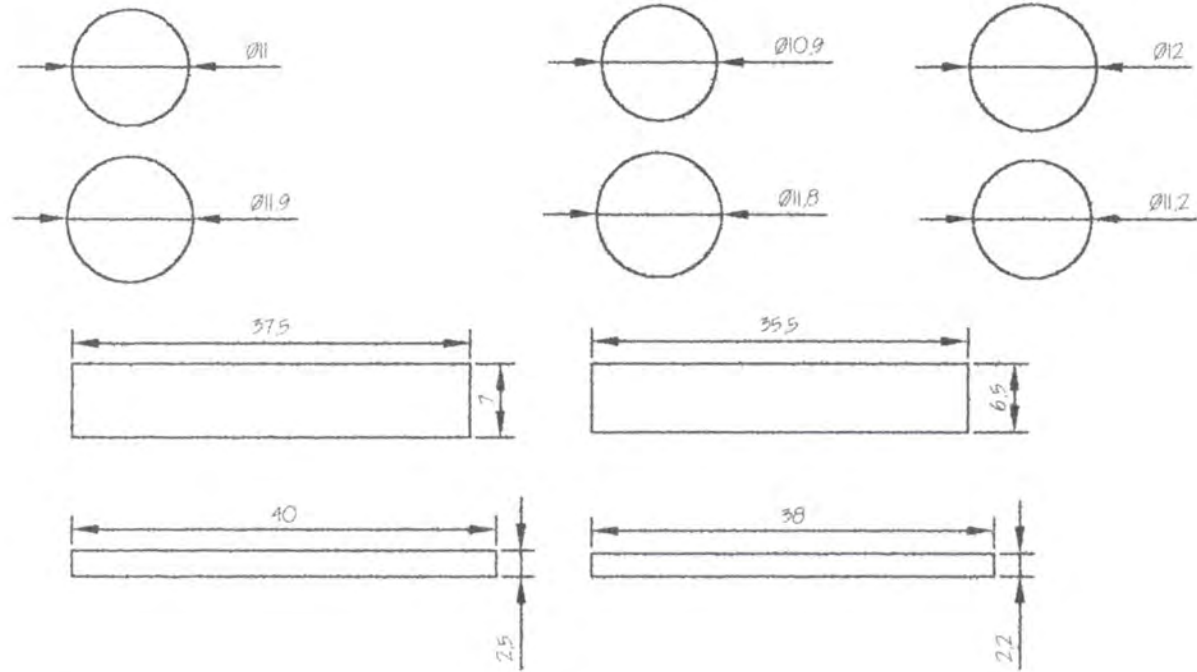

Caja Redonda No. 3

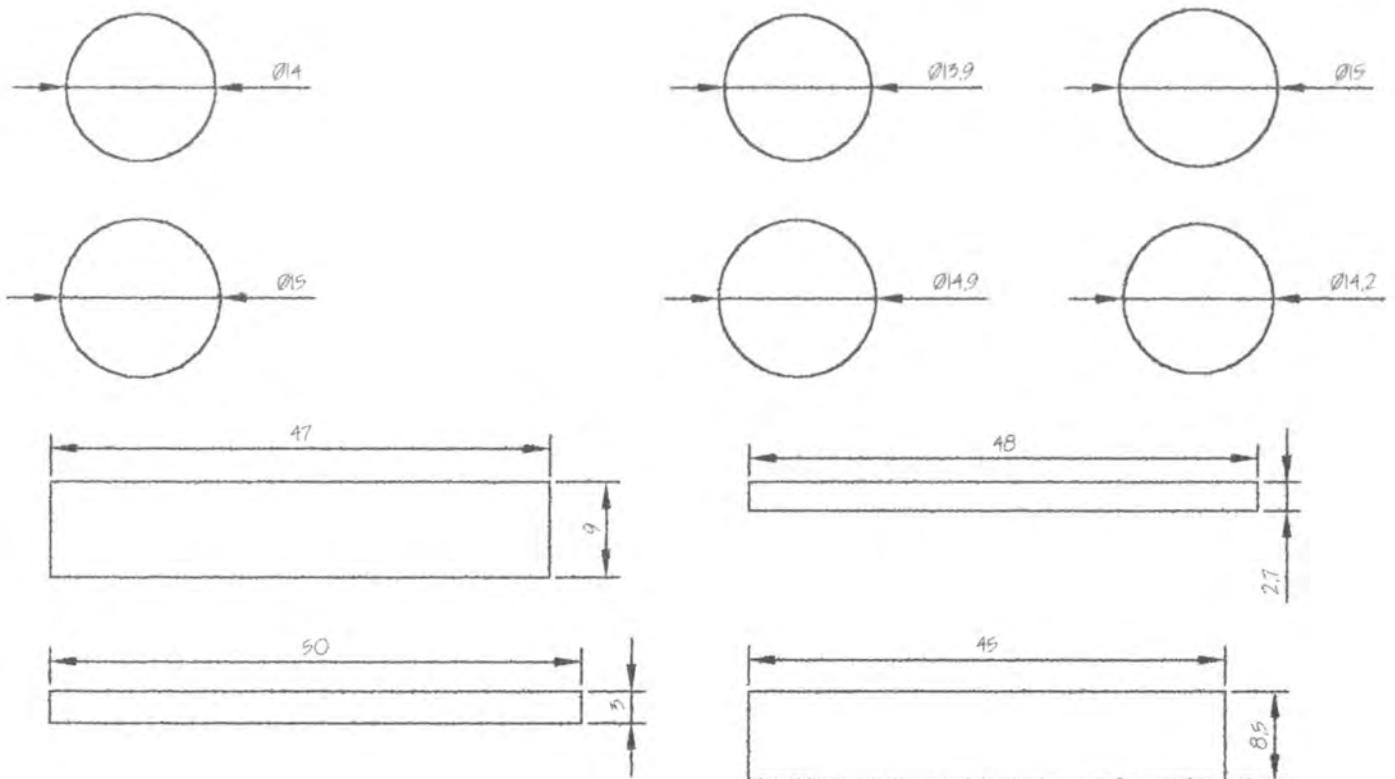

Medida No. 2

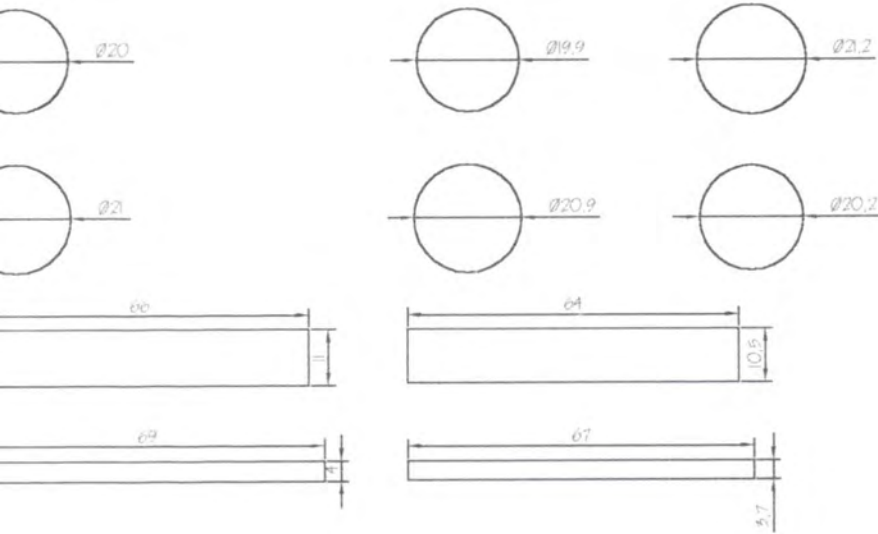

Medida No. 1

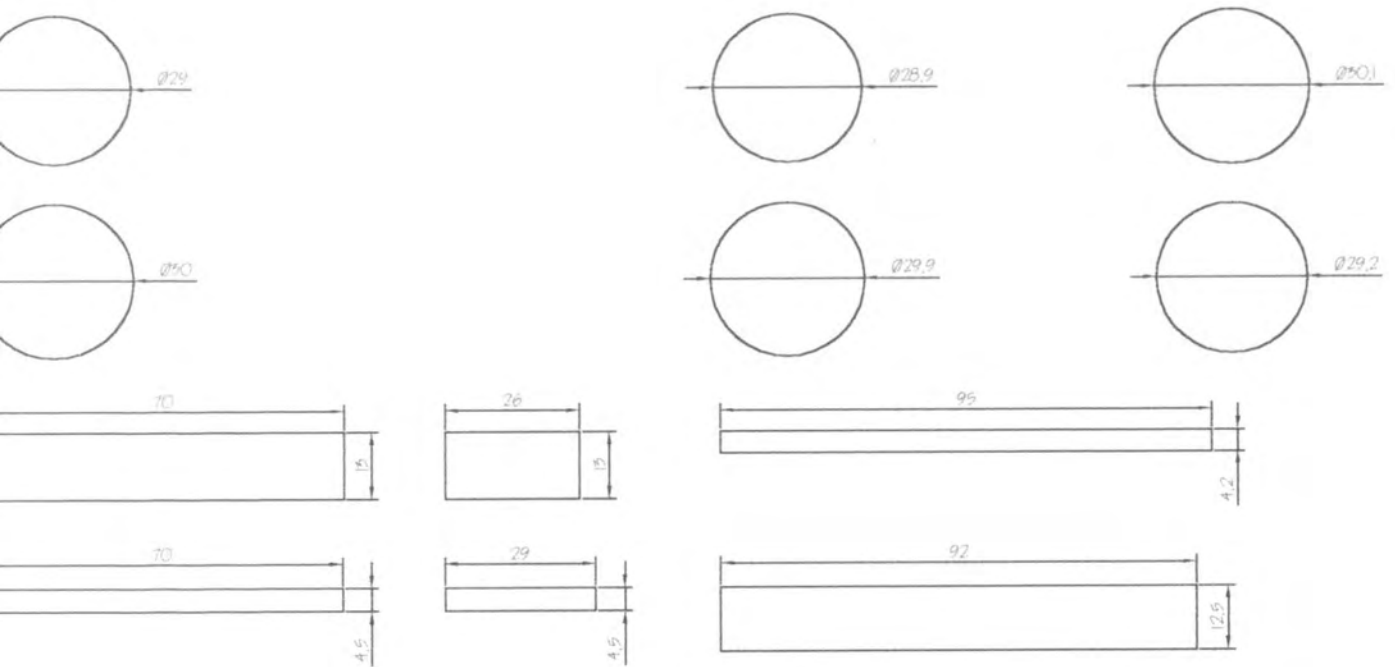

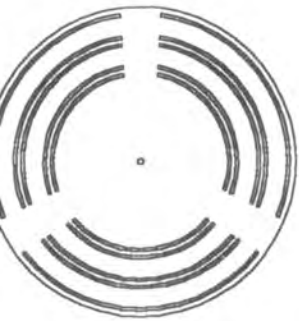

MOLDE PARA
CARTON CRAFT



MOLDE PARA CARTON
CARTULINA

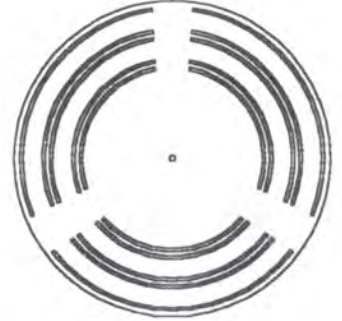

MOLDE PARA
EXTERIORES



REGLETA PARA LATERALES

DISEÑO DE MOLDES PARA EL
JUEGO DE CAJAS DE TIRAS
"LA ESPERANZA"

Tiras No. 1

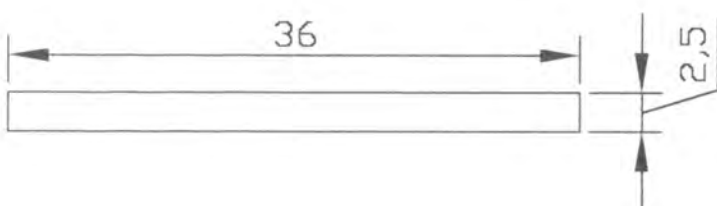
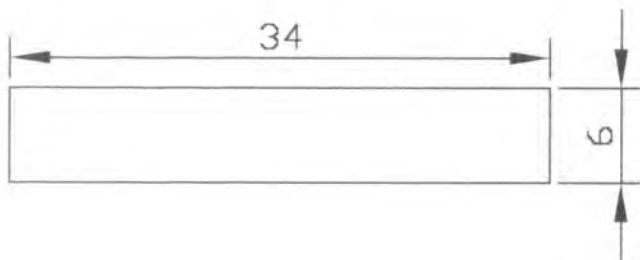
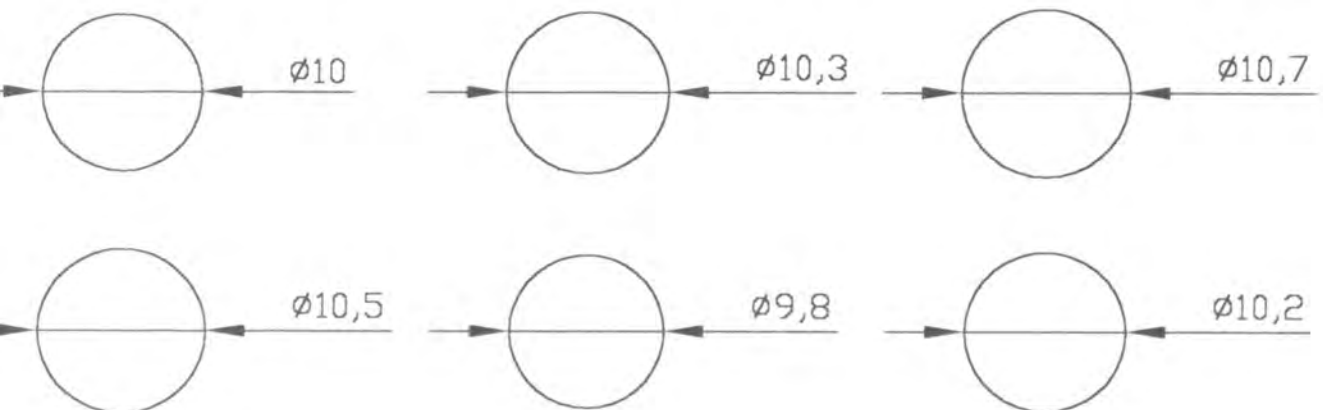

Caja Tiras No. 3

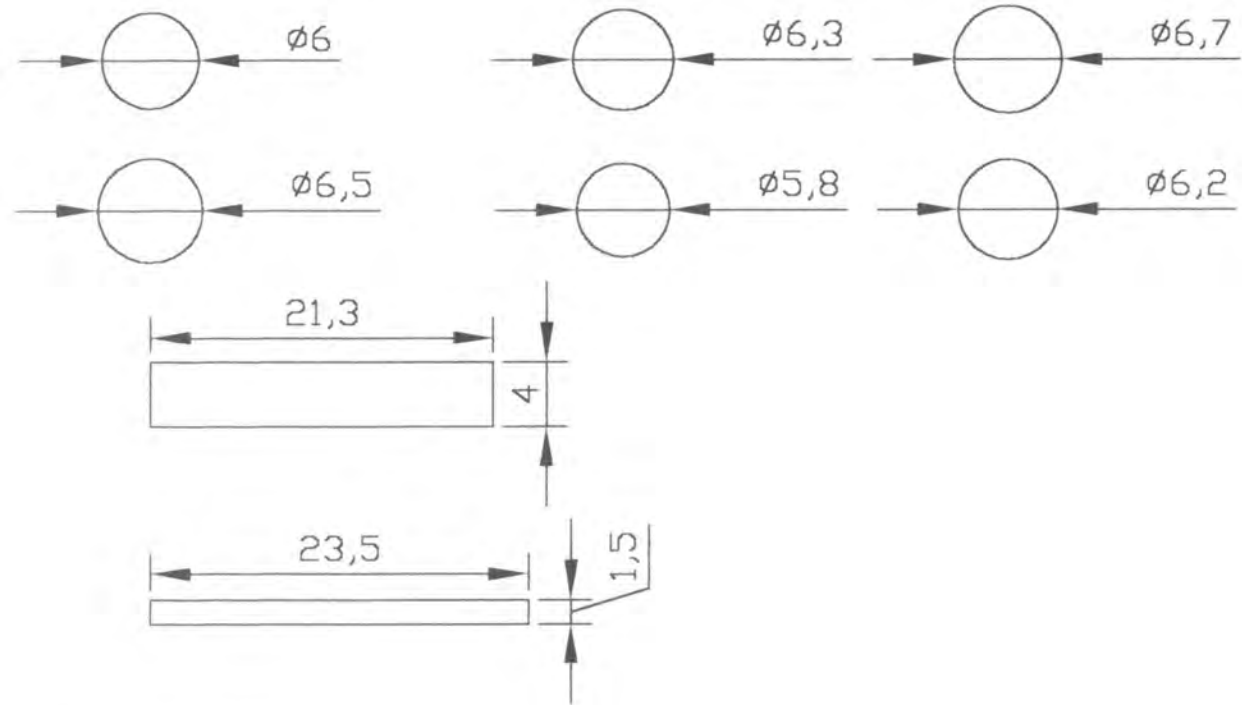

Caja Tiras No. 2

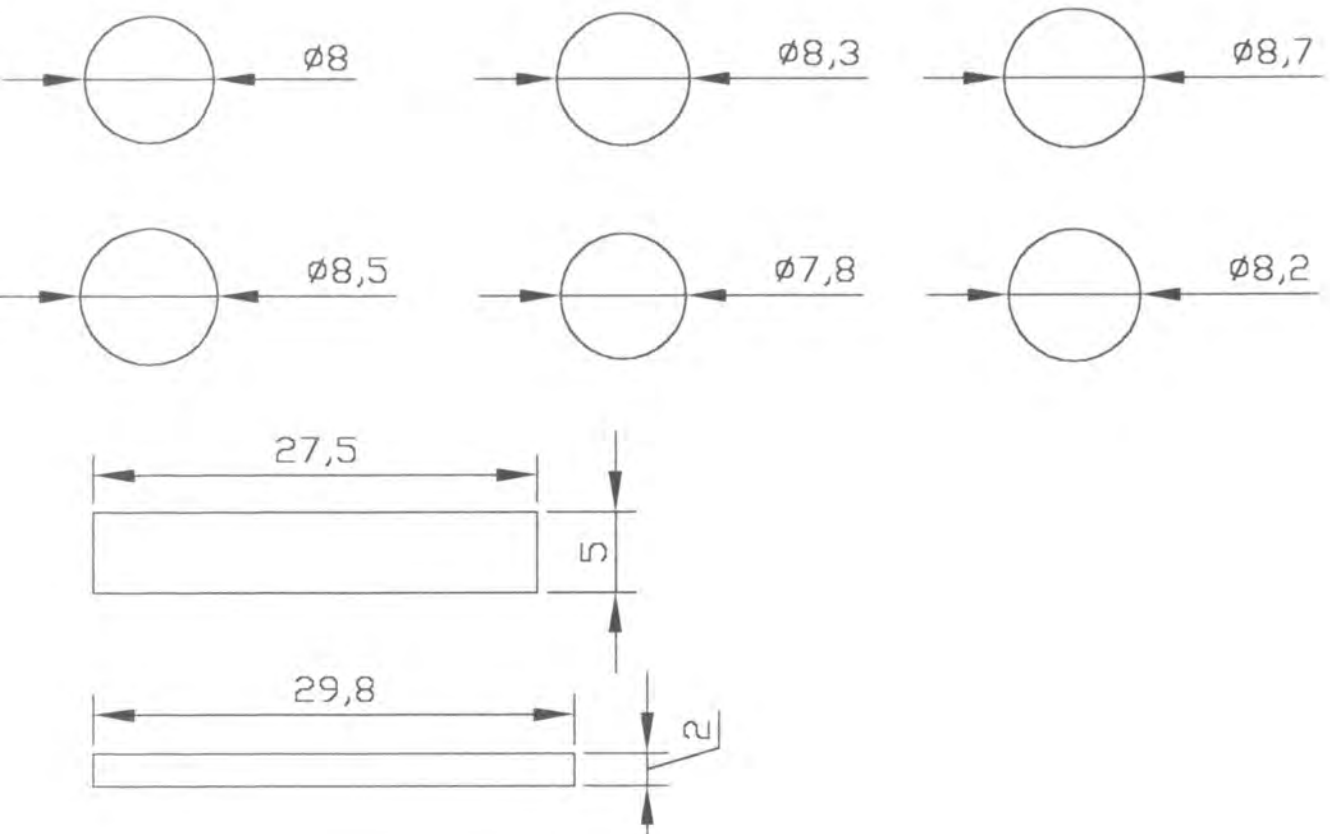

DISEÑO DE MOLDES PARA
EL JUEGO DE CAJAS REDONDAS
"EL CANEY"

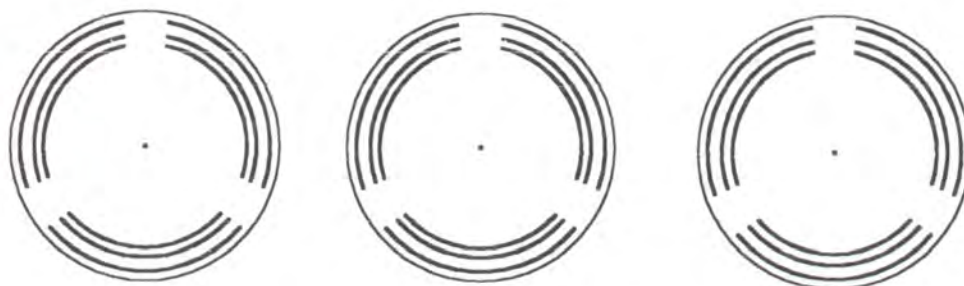

El Caney¹¹
Medonda Entretetijida No. 1

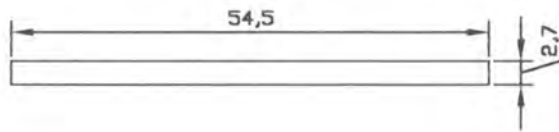
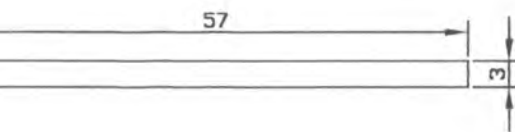
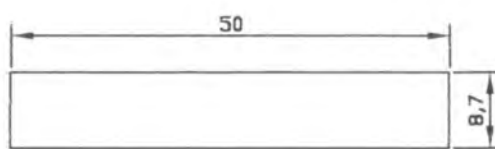
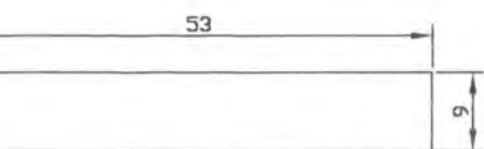
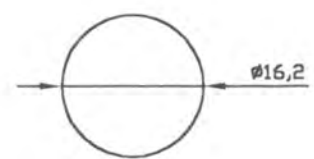
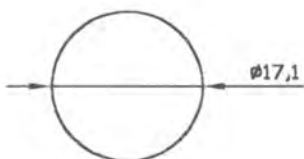
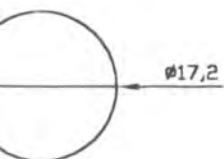
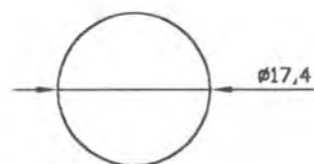
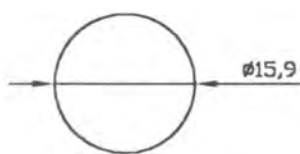
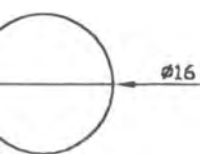

Redonda Entretejada No. 2

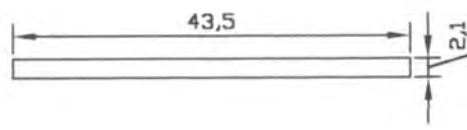
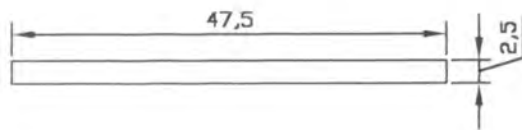
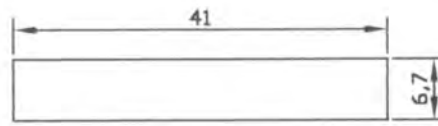
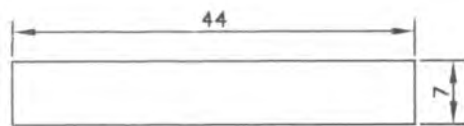
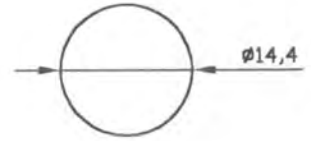
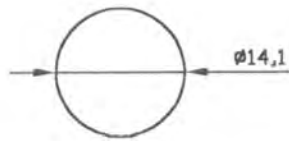
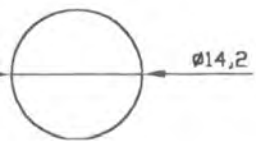
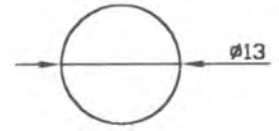
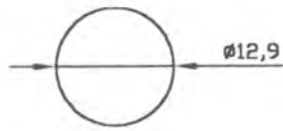

DISEÑO DE MOLDES PARA
EL JUEGO DE CAJAS REDONDAS
"ASOCIACION DE MUJERES DE
SOMONDOCO"



"Asociación de Mujeres de Somondoco"
Caja Redonda No. 1

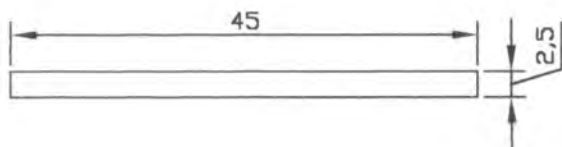
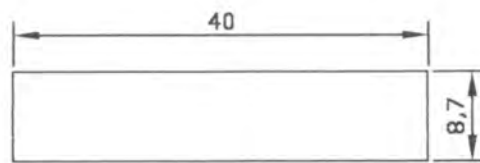
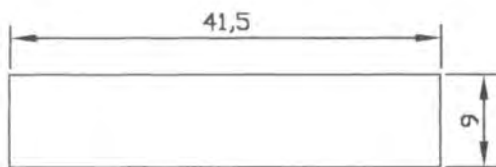
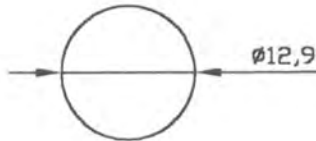
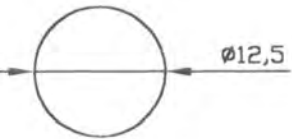
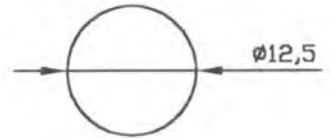
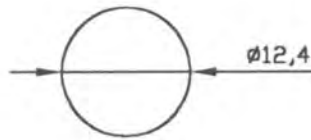
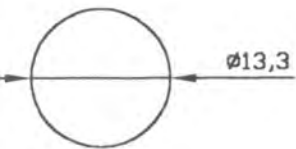

Caja Redonda No. 2

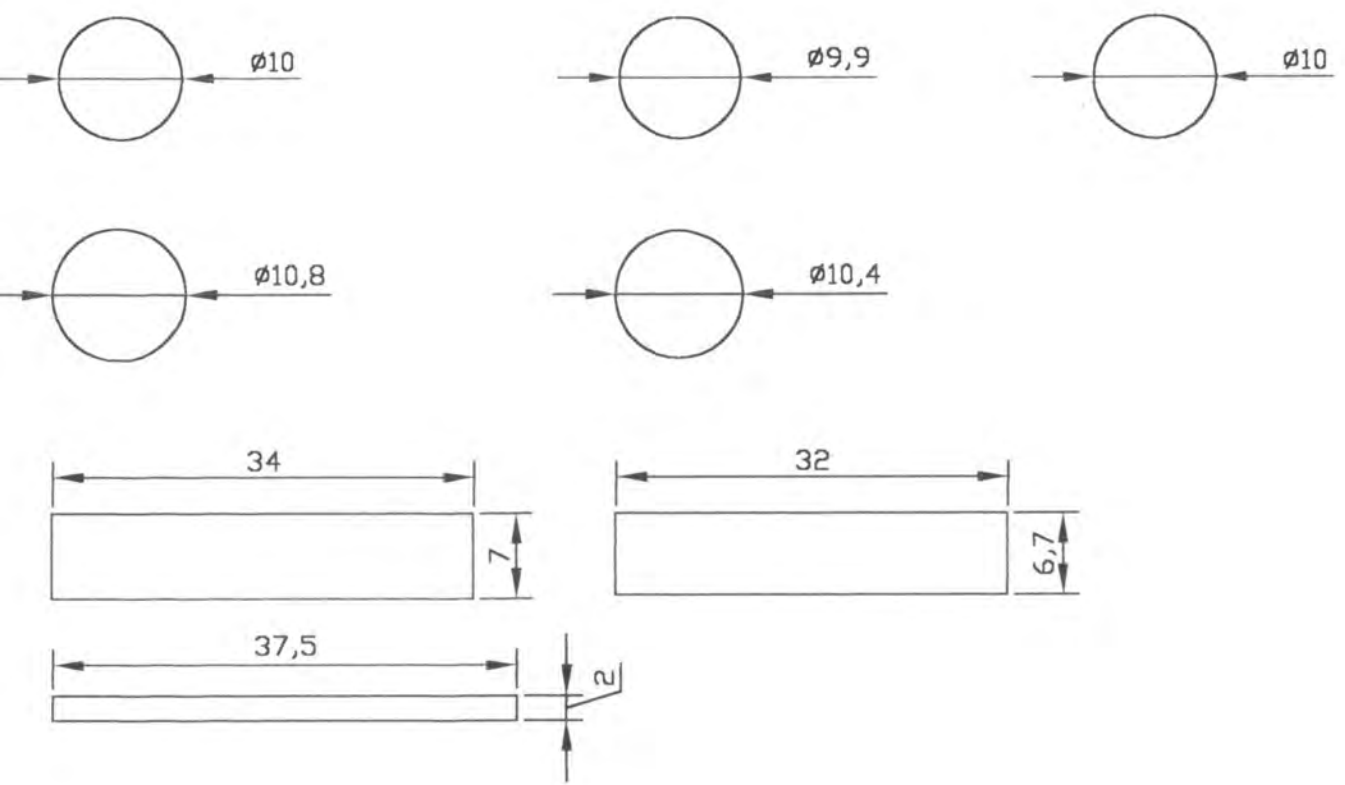

Caja Redonda No. 3

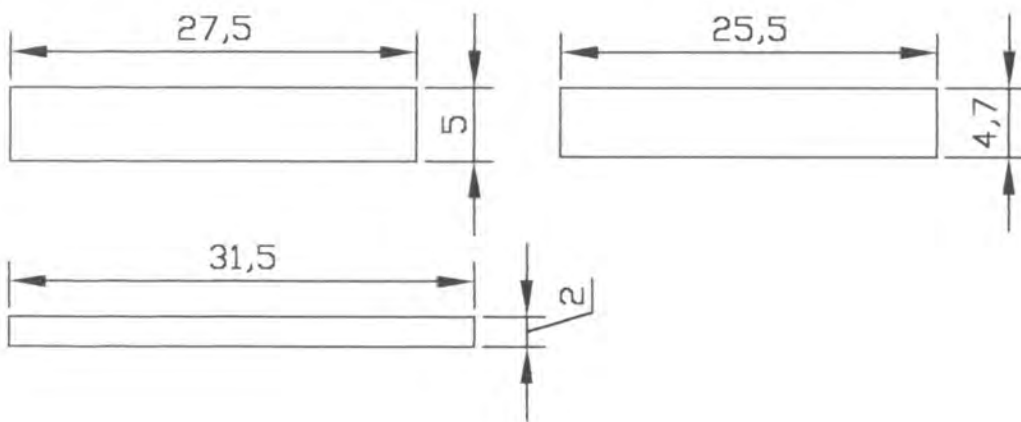
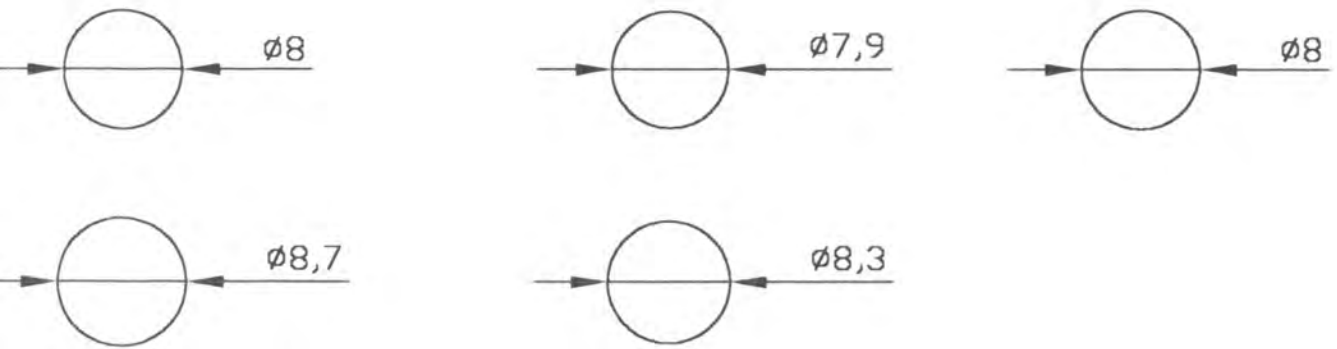

DISEÑO DE MOLDES PARA
EL JUEGO DE CAJAS CILINDRICAS
"ASOCIACION DE MUJERES DE
SOMONDOCO"

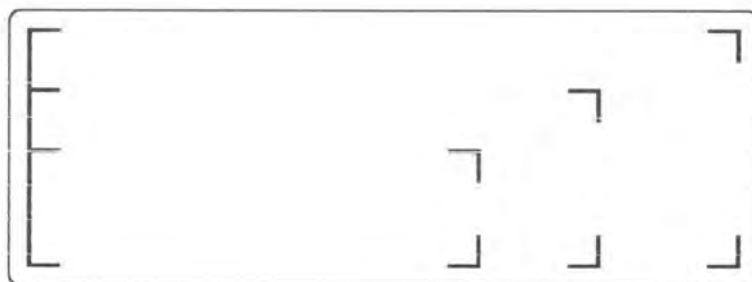
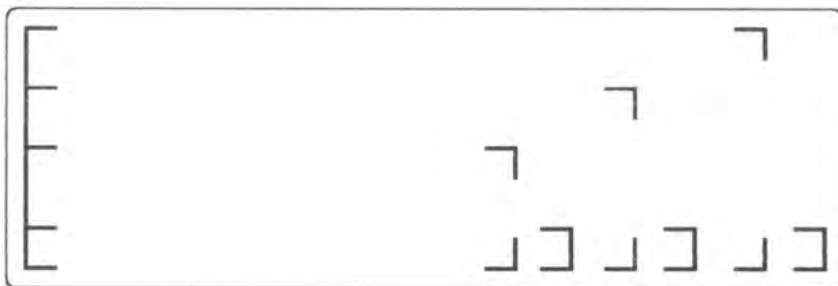

'Asociación de Mujeres de
Somondoco'
Caja Cilindrica No. 1

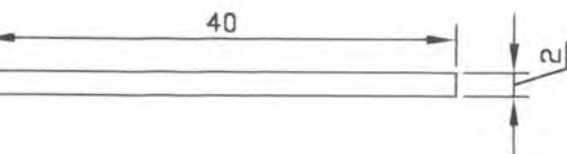
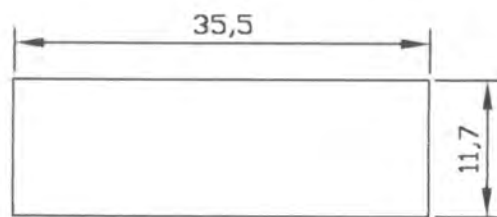
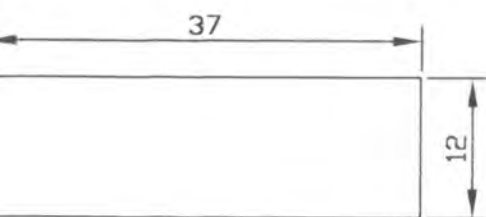
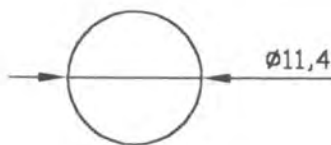
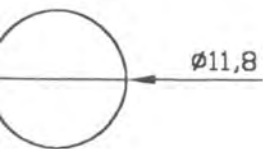
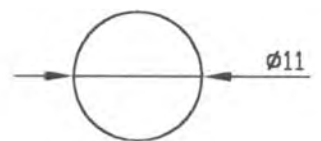
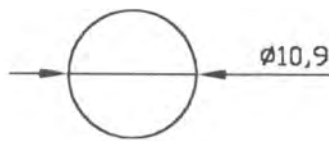
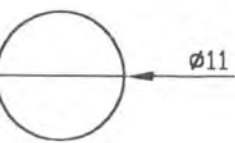

Caja Cilindrica No. 2

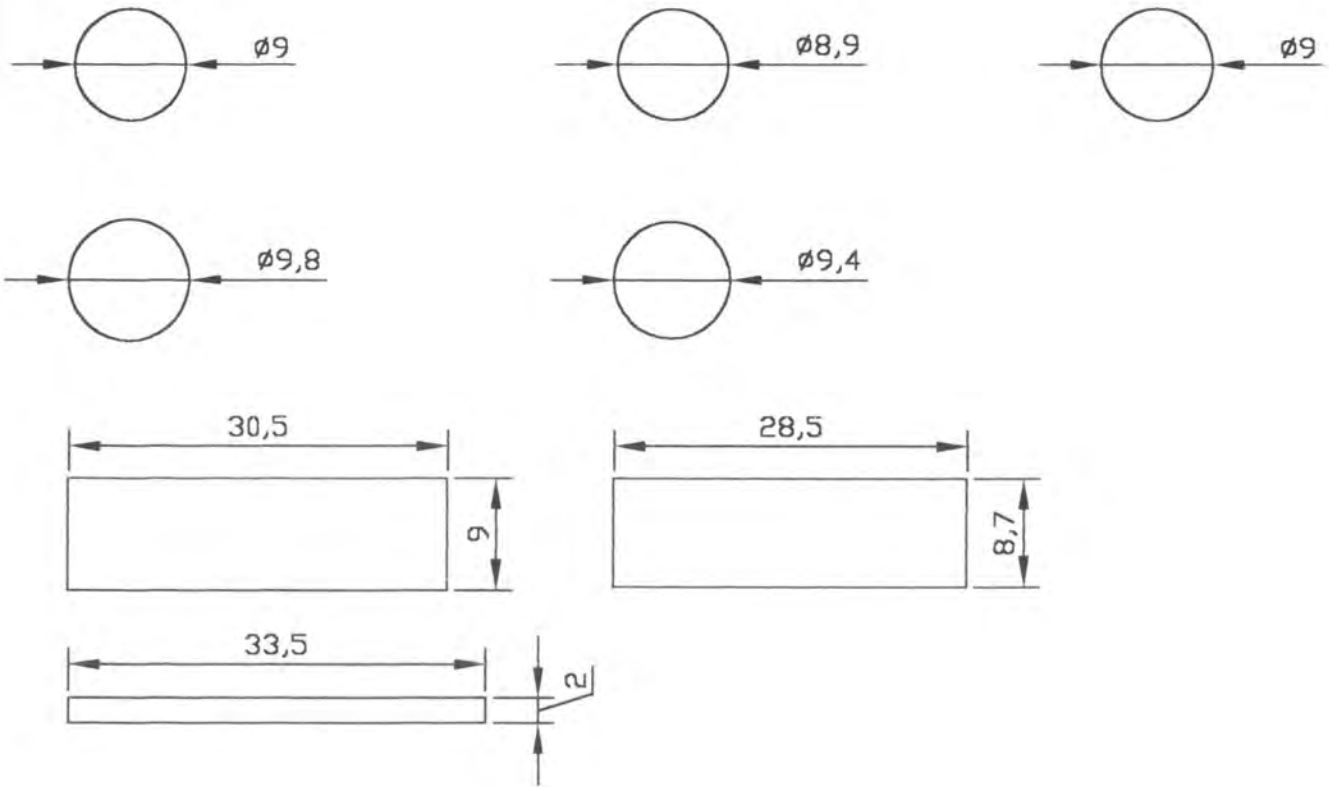

Caja Cilindrica No. 3

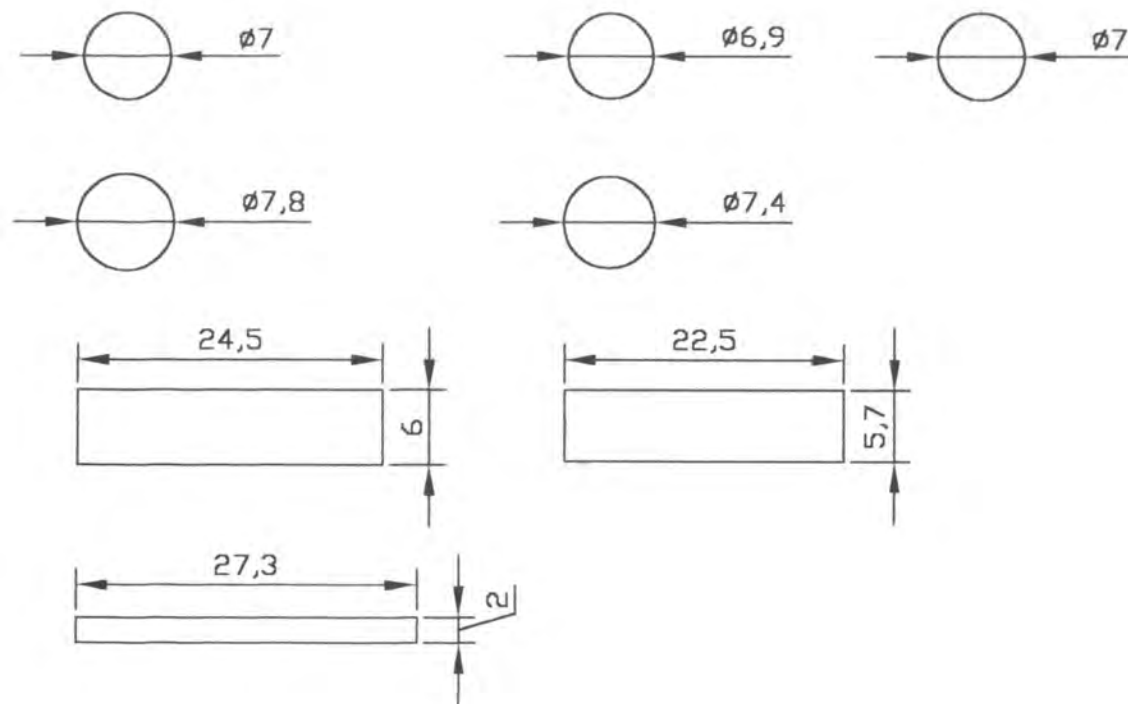

DISEÑO DE MOLDES PARA
EL JUEGO DE CAJAS REDONDAS
"LA HOJARASCA"

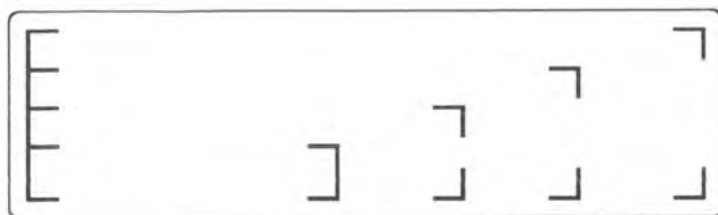
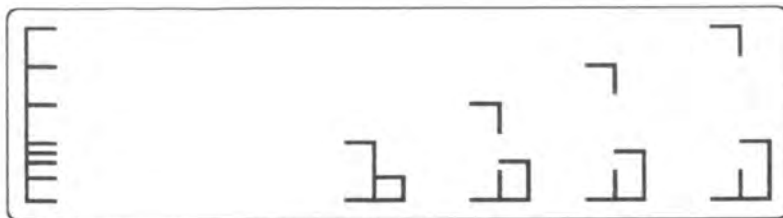

Taller "La Hojarasca"
Caja Redonda No. 1

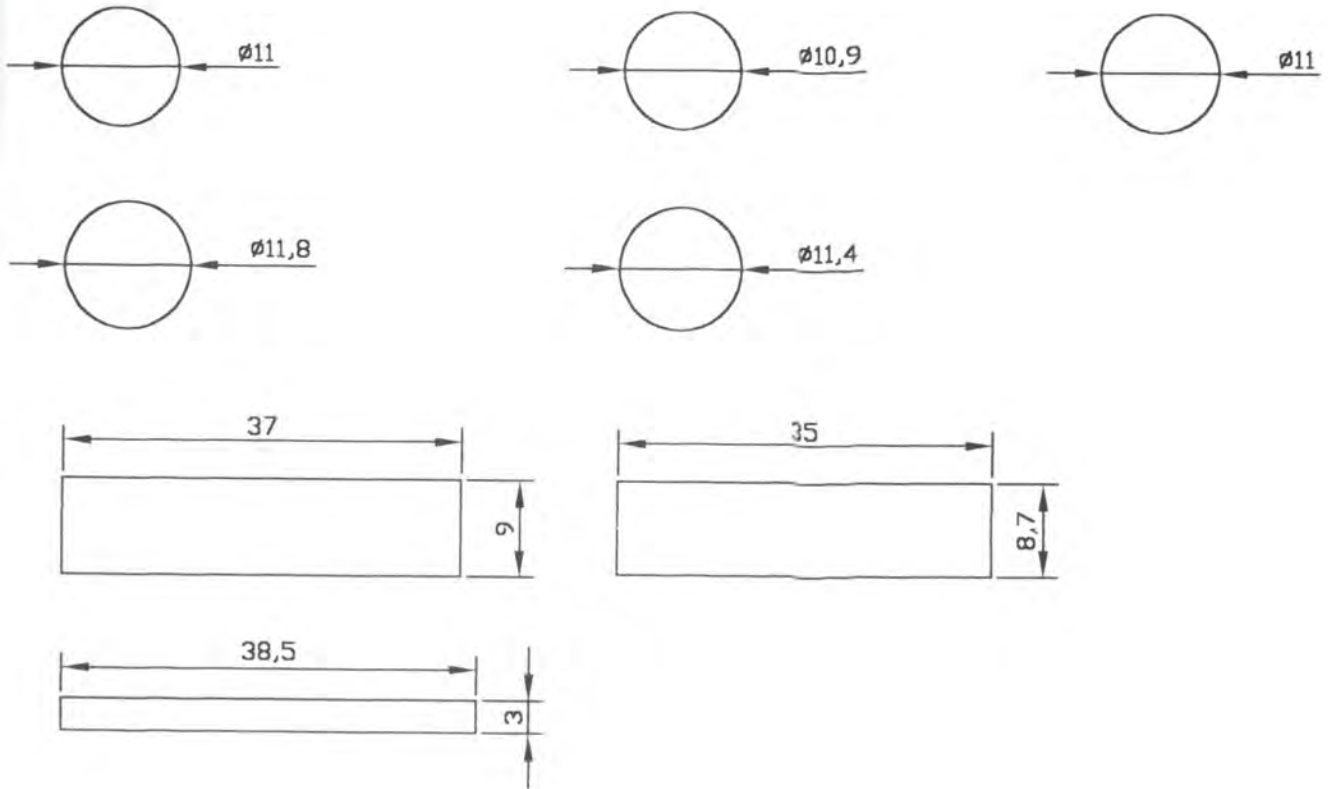

Caja Redonda No. 2

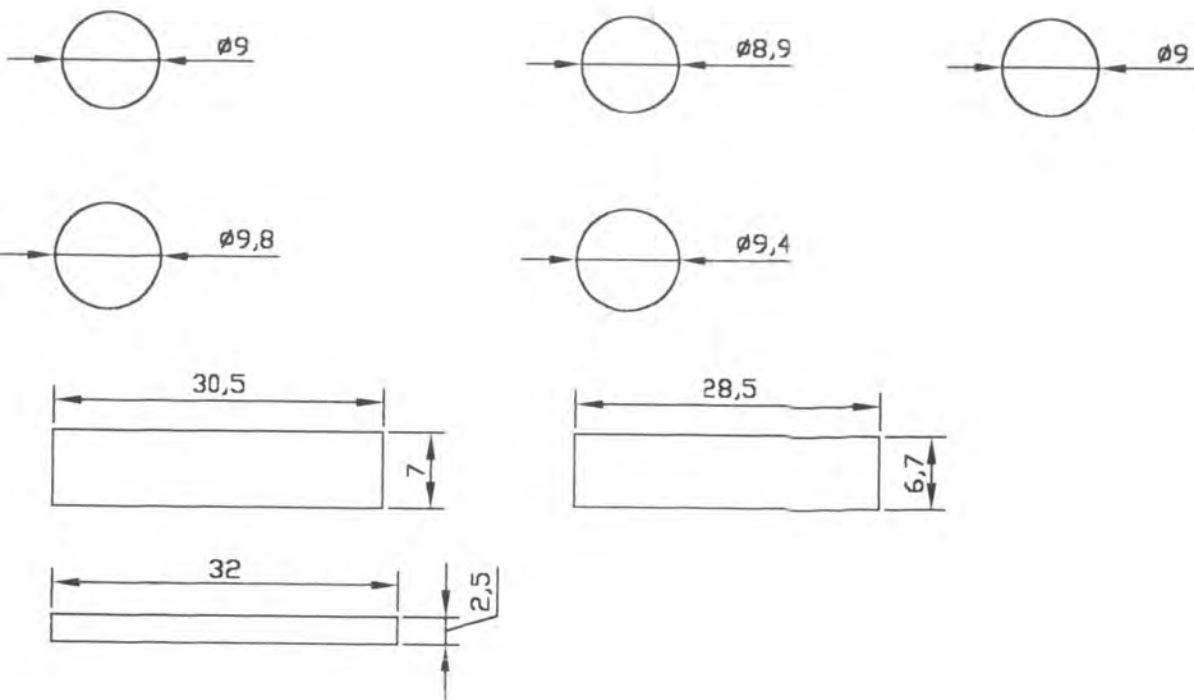

Caja Redonda No. 3

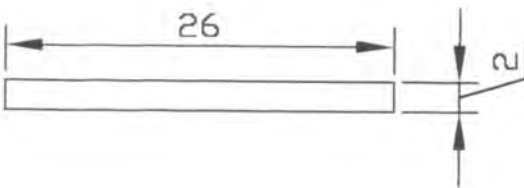
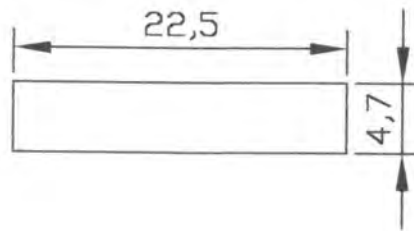
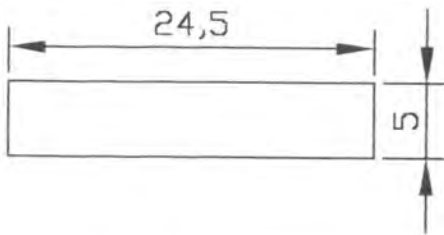
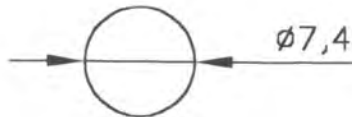
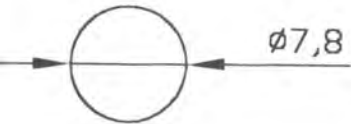
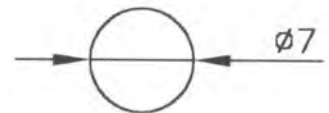
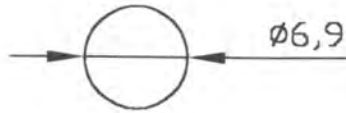
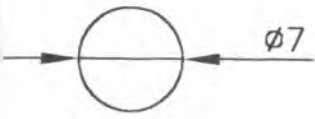

Caja Redonda No. 4

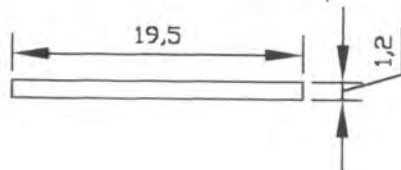
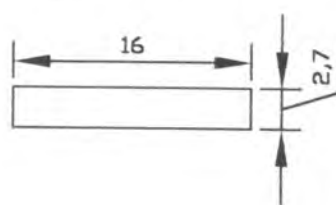
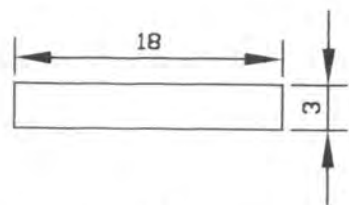

DISEÑO DE MOLDES PARA
EL JUEGO DE CAJAS CILINDRICAS
"LA HOJARASCA"

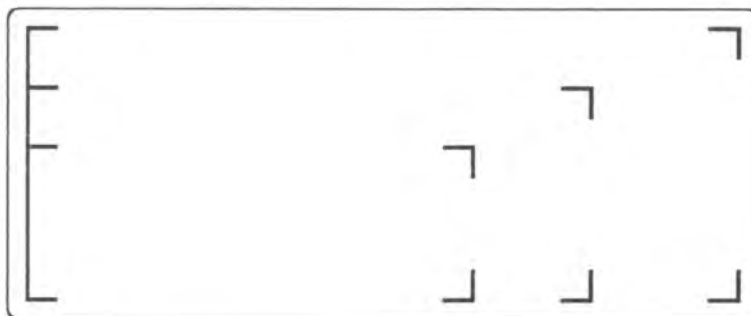

Waller "La Hojarasca"
Caja Cilindrica No. 1

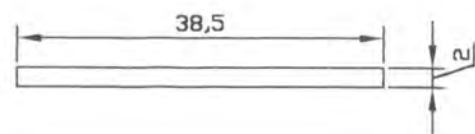
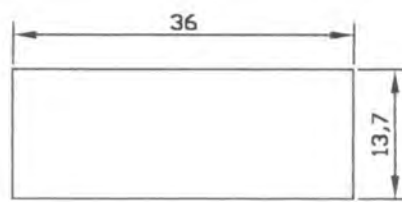
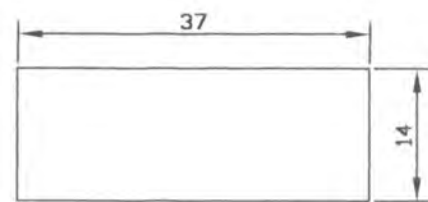
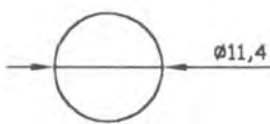
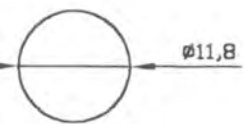
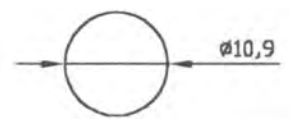
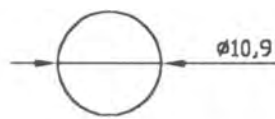
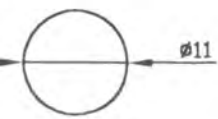

Caja Cilindrica No. 2

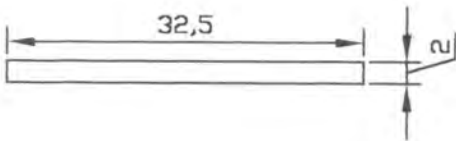
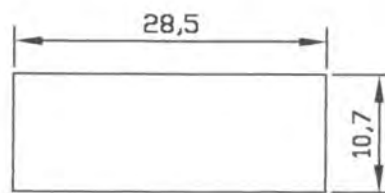
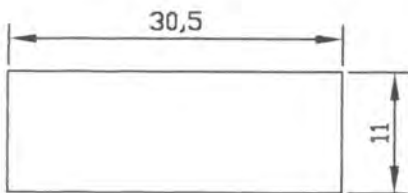
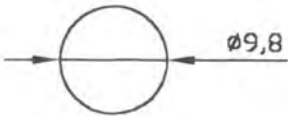
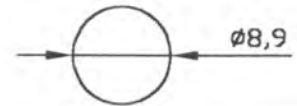
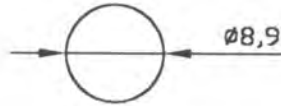
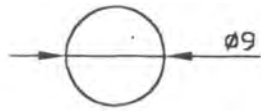

Caja Cilindrica No. 3

