



ARTESANIAS DE COLOMBIA S.A.  
CONVENIO CAMARA DE COMERCIO DE BOGOTÁ,  
CONCURSO PROVOCATE DE CUNDINAMARCA.

**Proyecto**  
**“Taller de asesorías para los ganadores del concurso “Provócate de Cundinamarca” categoría de artesanías.”**

**Asesoría en Diseño: Puesta a punto del producto**

**Anexo**

**Fichas técnicas de diseño**

**Asesor: DI. Yilber González Reyes**

**Convenio Artesanías de Colombia S.A – Gobernación de  
Cundinamarca  
Bogotá DC.  
2008**

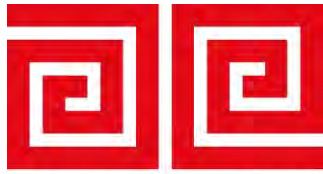

artesanías de colombia s.a.

## Planos técnicos

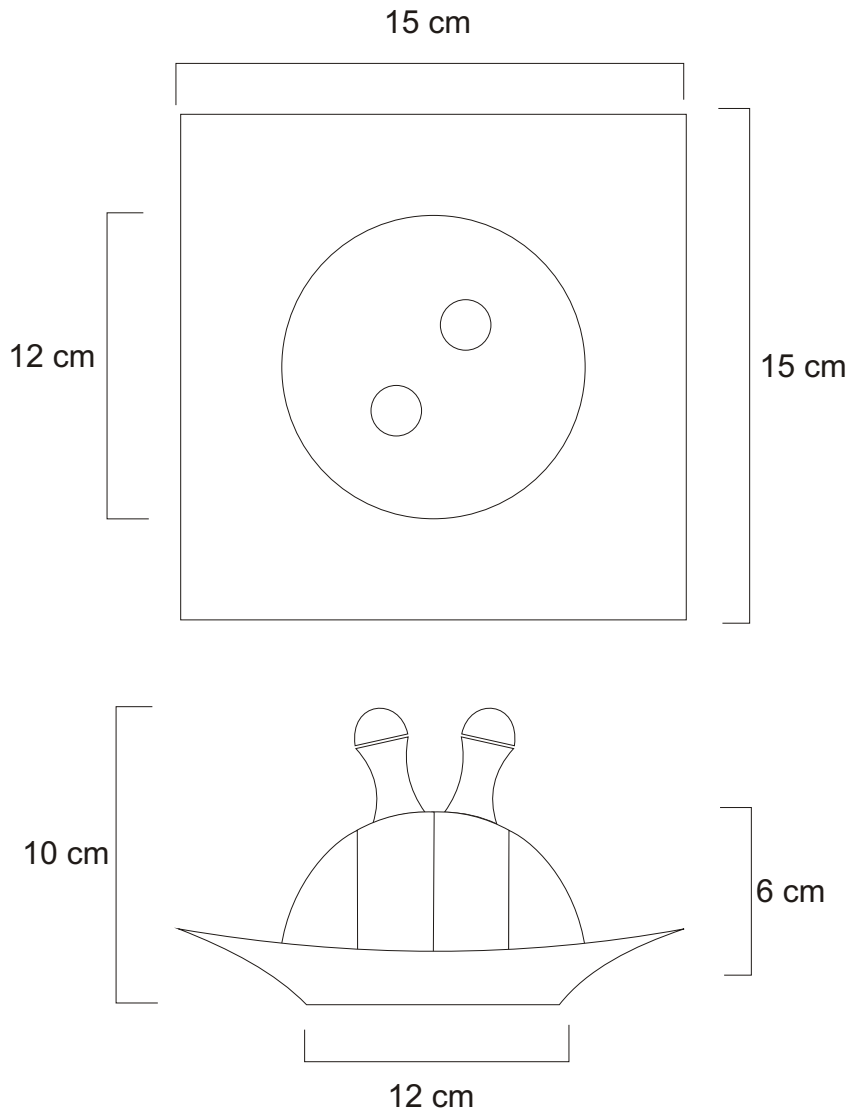

provócate  
DE CUNDINAMARCA

## Producto referente



## Producto mejorado

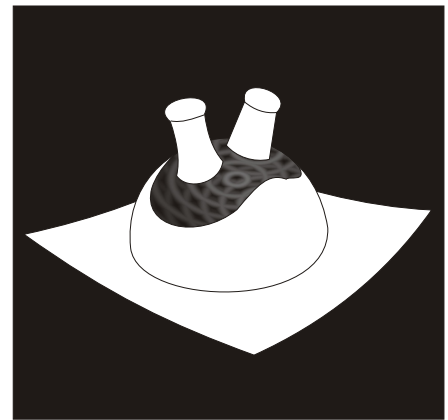

**Unidad Productiva:** Cerámicas de Guatavita

**Representante:** Luis Hernando Prieto

**Código:** 3323

**Categoría:** Mesa y Cocina, decoración y hogar

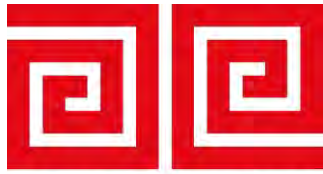

artesanías de colombia s.a.

Planos técnicos

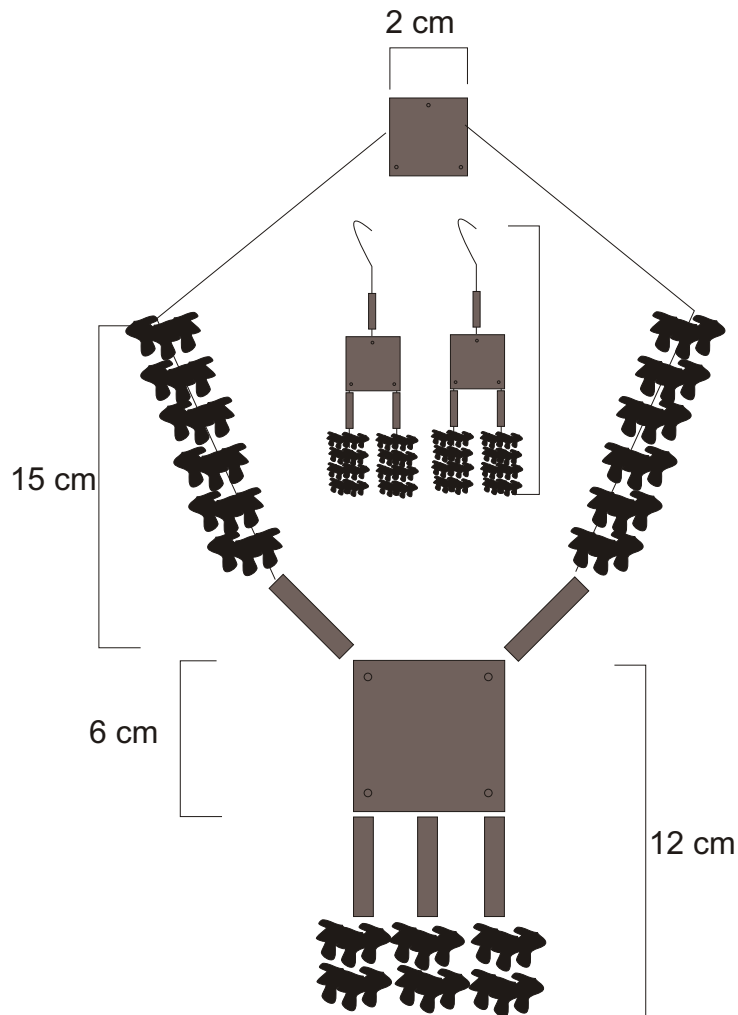

provócate  
DE CUNDINAMARCA

Producto referente



Producto mejorado



**Unidad Productiva:** Arte Ducafi

**Representante:** María Dubis Castro Fierro

**Código:** 583

**Categoría:** Accesorios de Moda

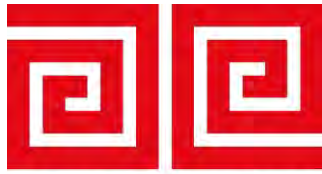

artesanías de colombia s.a.

Planos técnicos



Tejido de muestra

45 cm

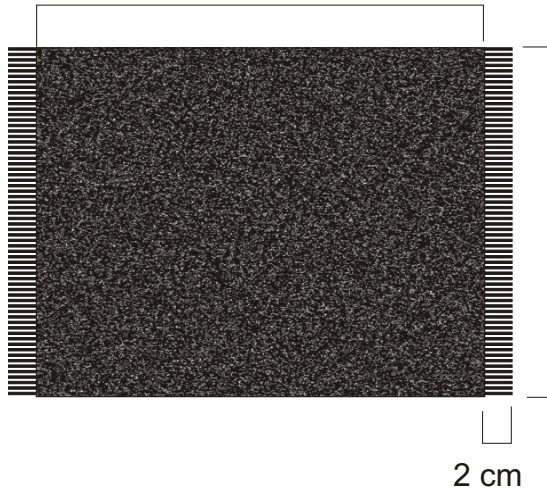

35 cm

2 cm



provócate  
DE CUNDINAMARCA

Producto referente



Producto mejorado



**Unidad Productiva:** Telar Manual

**Representante:** Edward Alberto fernández

**Código:** 1333

**Categoría:** Mesa y Cocina, decoración y hogar

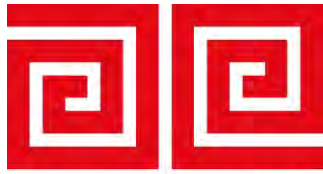

artesañas de colombia s.a.

Planos técnicos

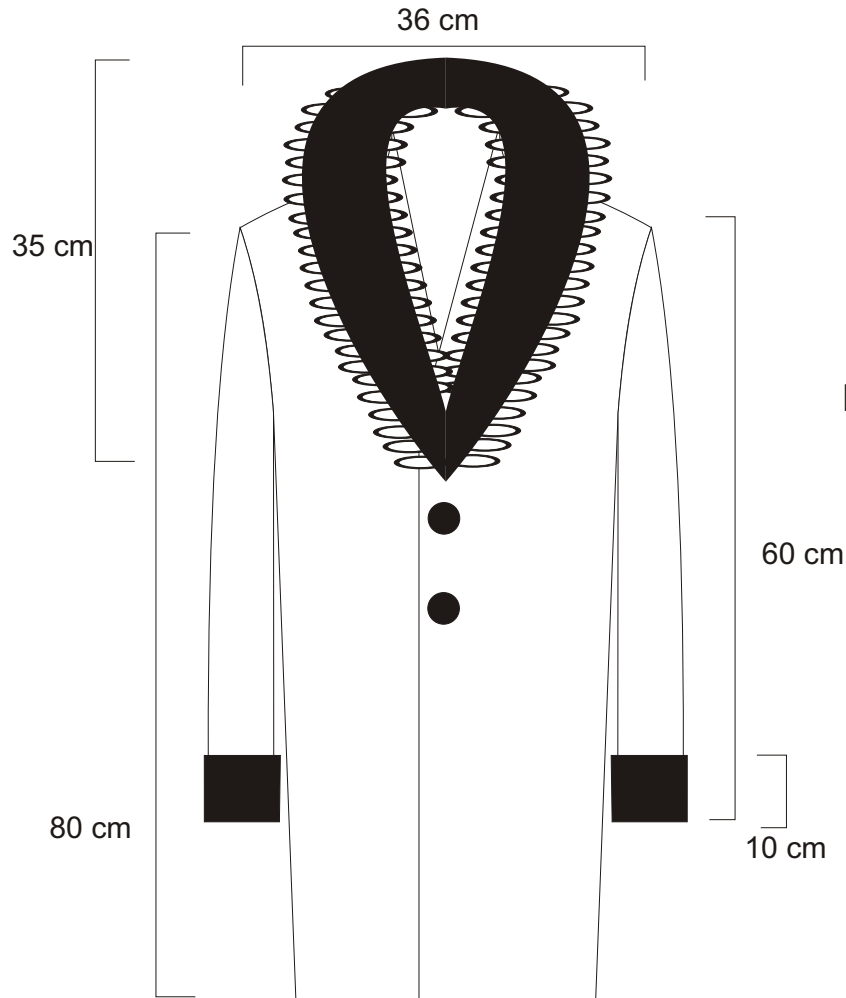

provócate  
DE CUNDINAMARCA

Producto referente



Producto mejorado



Talla 10

**Unidad Productiva:** Tejido OVE

**Representante:** Leopoldina Jiménez

**Código:** 3866

**Categoría:** Prendas de vestir

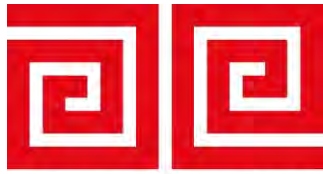

artesañas de colombia s.a.

Planos técnicos



provócate  
DE CUNDINAMARCA

Producto referente



Producto mejorado

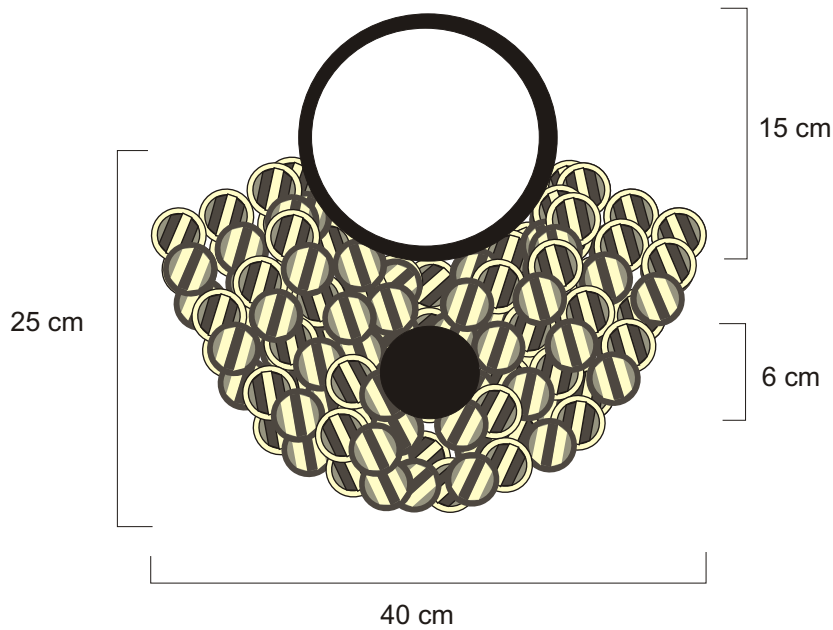

**Unidad Productiva:** Creaciones Lunita

**Representante:** Gloria Marina Pineda

**Código:** 1421

**Categoría:** Accesorios de Moda



artesañas de colombia s.a.

Planos técnicos

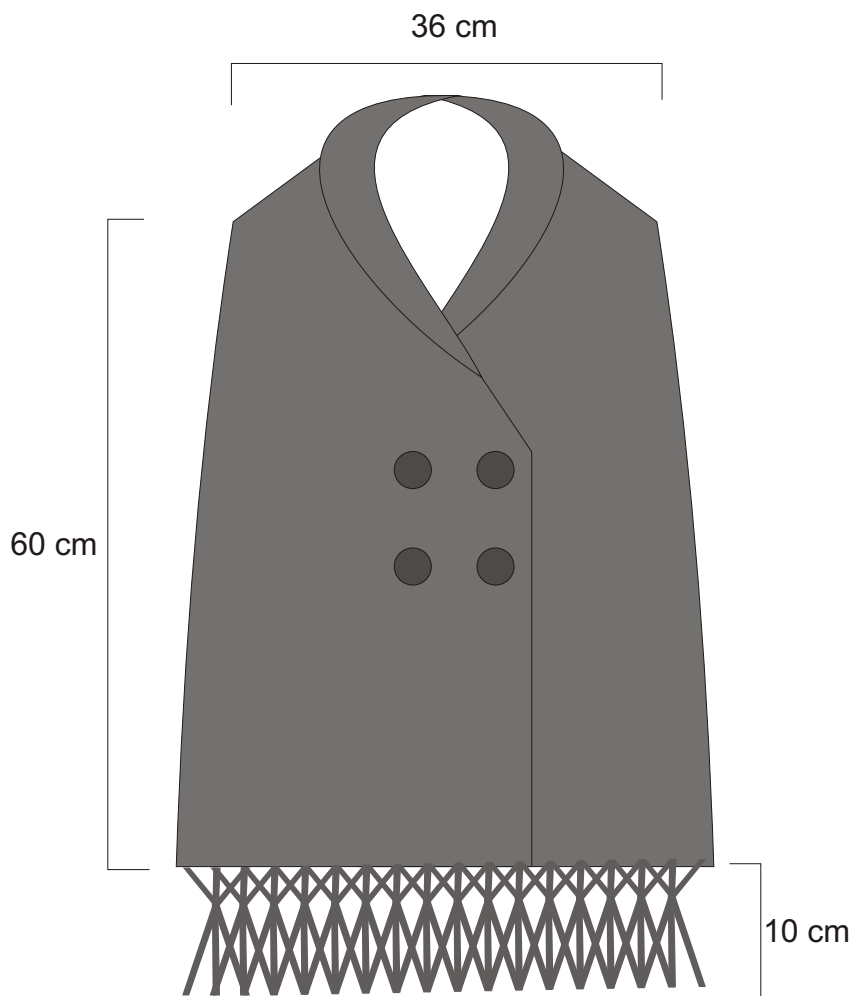

provócate  
DE CUNDINAMARCA

Producto referente



Producto mejorado



Talla 10

**Unidad Productiva:** Sueños por Cucunuba

**Representante:** Luz Angela Cuevas

**Código:** 3206

**Categoría:** Prendas de Vestir

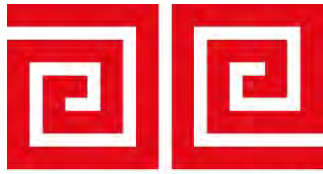

artesanías de colombia s.a.

Planos técnicos

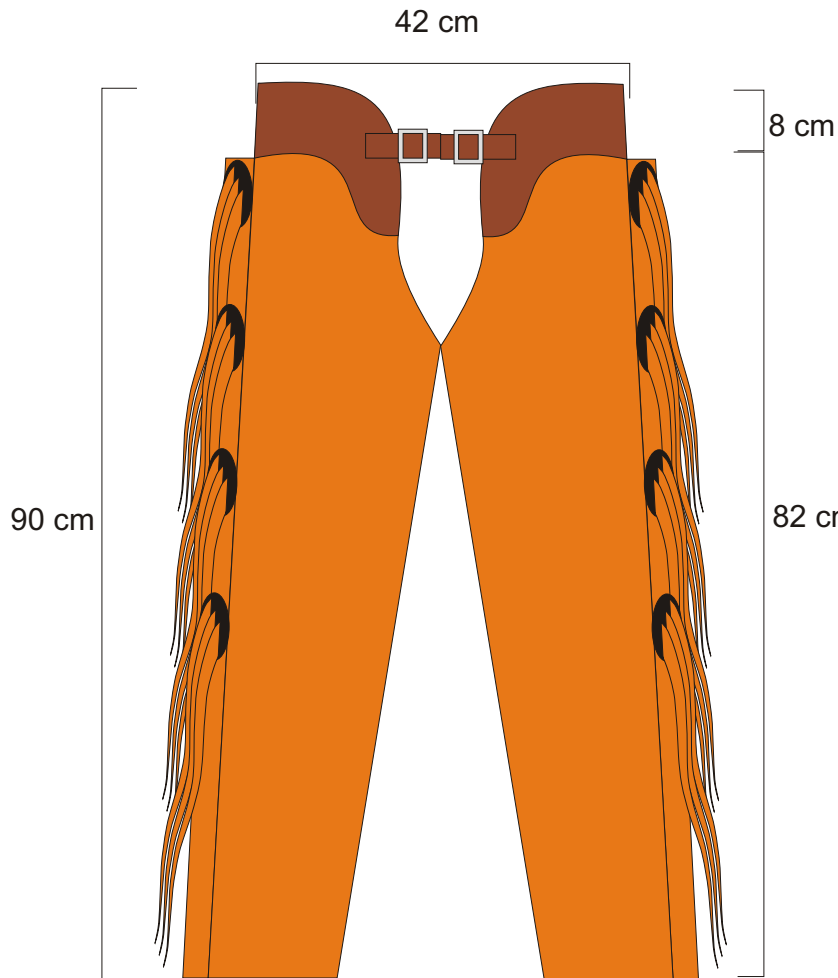

provócate  
DE CUNDINAMARCA

Producto referente



Producto mejorado



**Unidad Productiva:** M&M

**Representante:** Derlys Molano

**Código:** 1690

**Categoría:** Prendas de Vestir



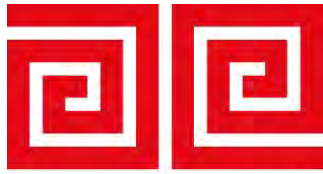

artesañas de colombia s.a.

Planos técnicos

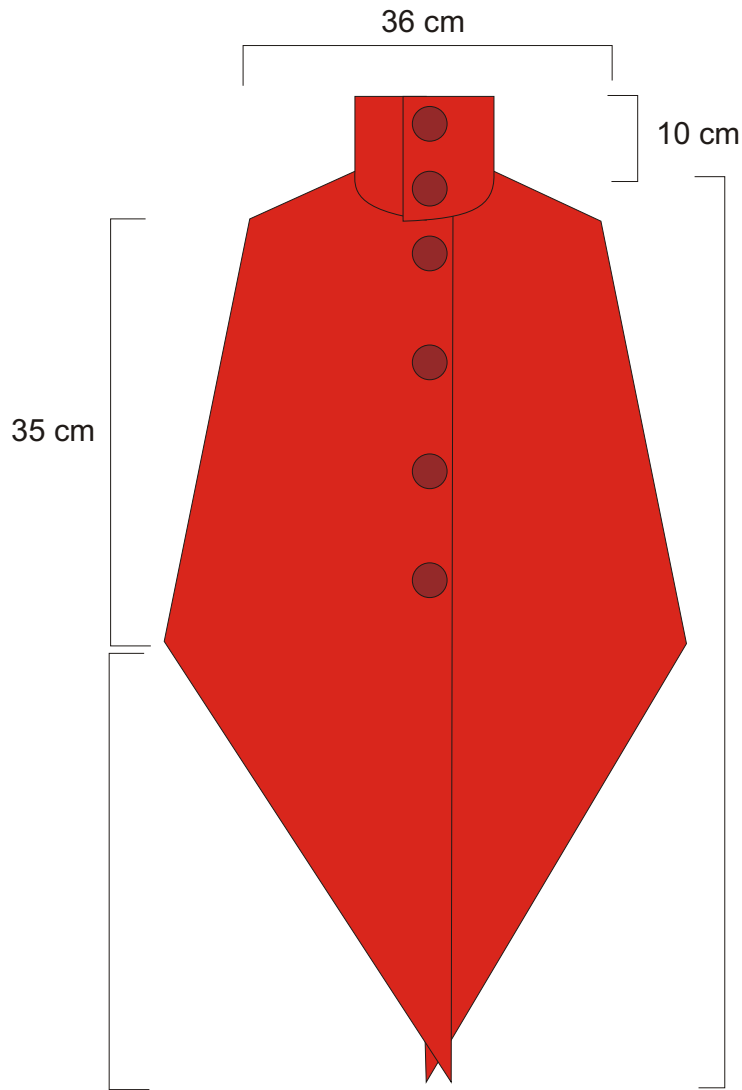

Talla 10



provócate  
DE CUNDINAMARCA

Producto referente



Producto mejorado



**Unidad Productiva:** Diana Murcia

**Representante:** Diana Esmeralda Murcia

**Código:** 3205

**Categoría:** Prendas de Vestir

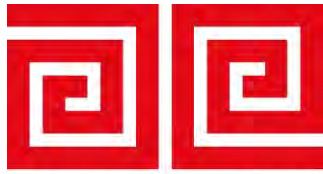

artesánías de colombia s.a.

Planos técnicos

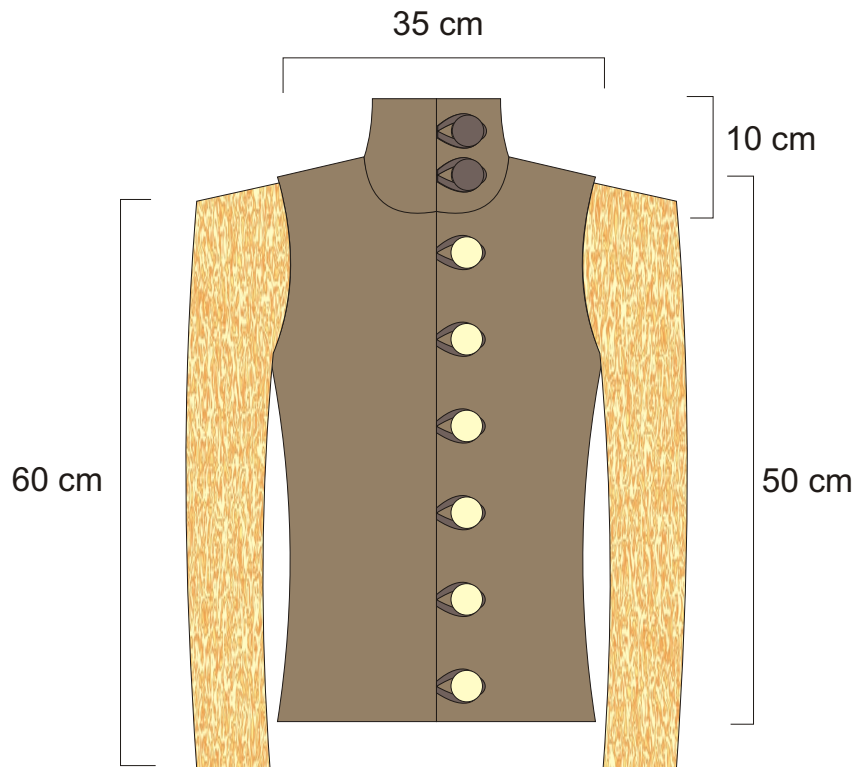

provócate  
DE CUNDINAMARCA

Producto referente



Producto mejorado



**Unidad Productiva:** APUC  
**Representante:** Luz María Rodríguez  
**Código:** 458  
**Categoría:** Prendas de Vestir

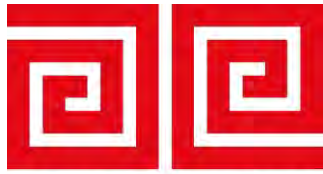

artesanías de colombia s.a.

Planos técnicos

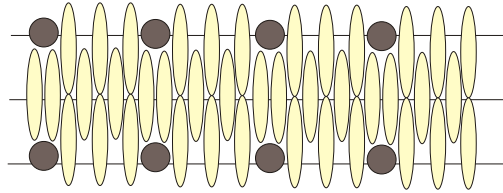

7 cm

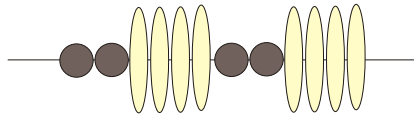
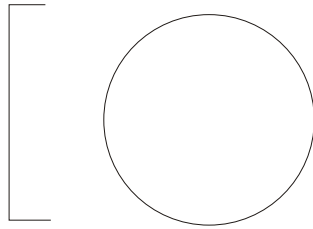

2 cm

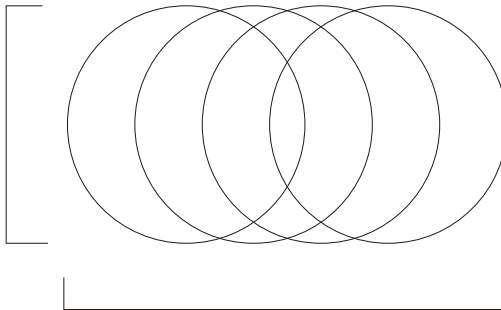

4 cm

Pulsera

Anillo



provócate  
DE CUNDINAMARCA

Producto referente



Producto mejorado



**Unidad Productiva: Alparcy Ltda**

**Representante:** Antonio Villareal

**Código:** 3014

**Categoría:** Accesorios de Moda

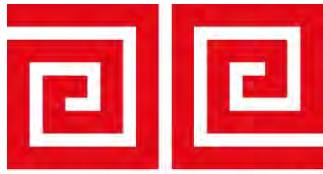

artesanías de colombia s.a.

Planos técnicos

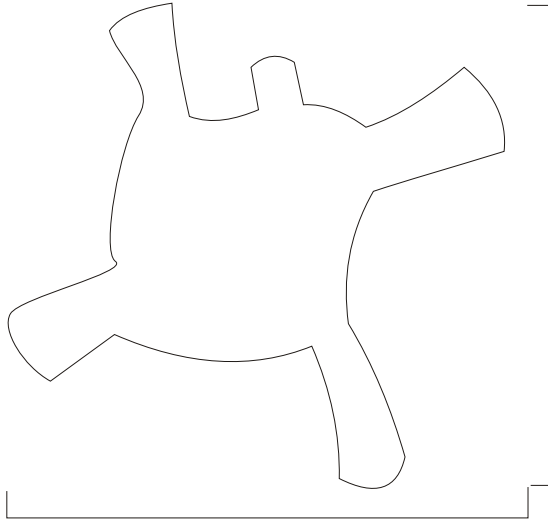

60 cm

60 cm

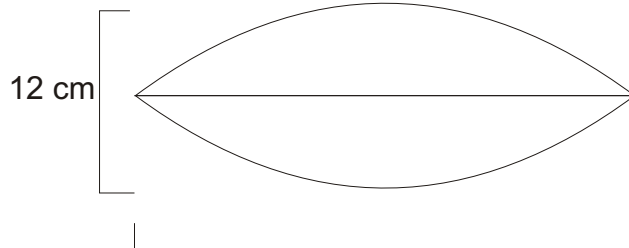

12 cm

60 cm



provócate  
DE CUNDINAMARCA

Producto referente



Producto mejorado

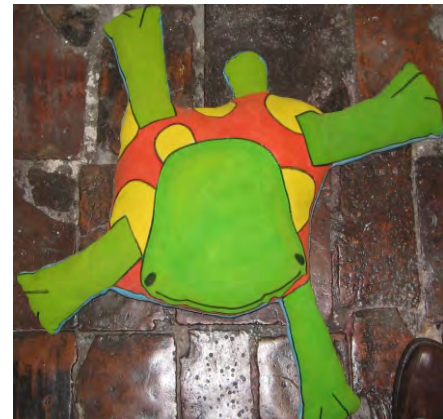

**Unidad Productiva:** Lio

**Representante:** Liliana Ortiz

**Código:** 3008

**Categoría:** Mesa y cocina, Hogar y decoración

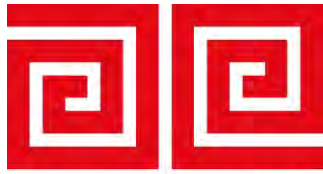

artesañas de colombia s.a.

Planos técnicos



provócate  
DE CUNDINAMARCA

Producto referente



Producto mejorado

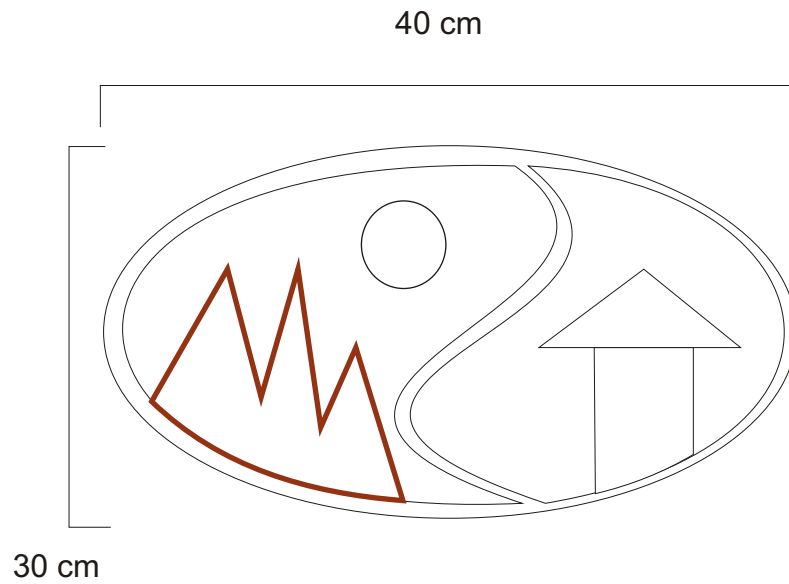

**Unidad Productiva:** Juca Pari

**Representante:** Julia Parra

**Código:** 1848

**Categoría:** Mesa y cocina, Hogar y decoración

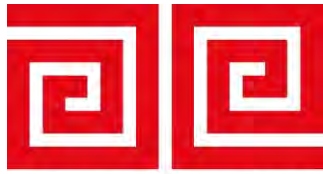

artesánías de colombia s.a.

Planos técnicos

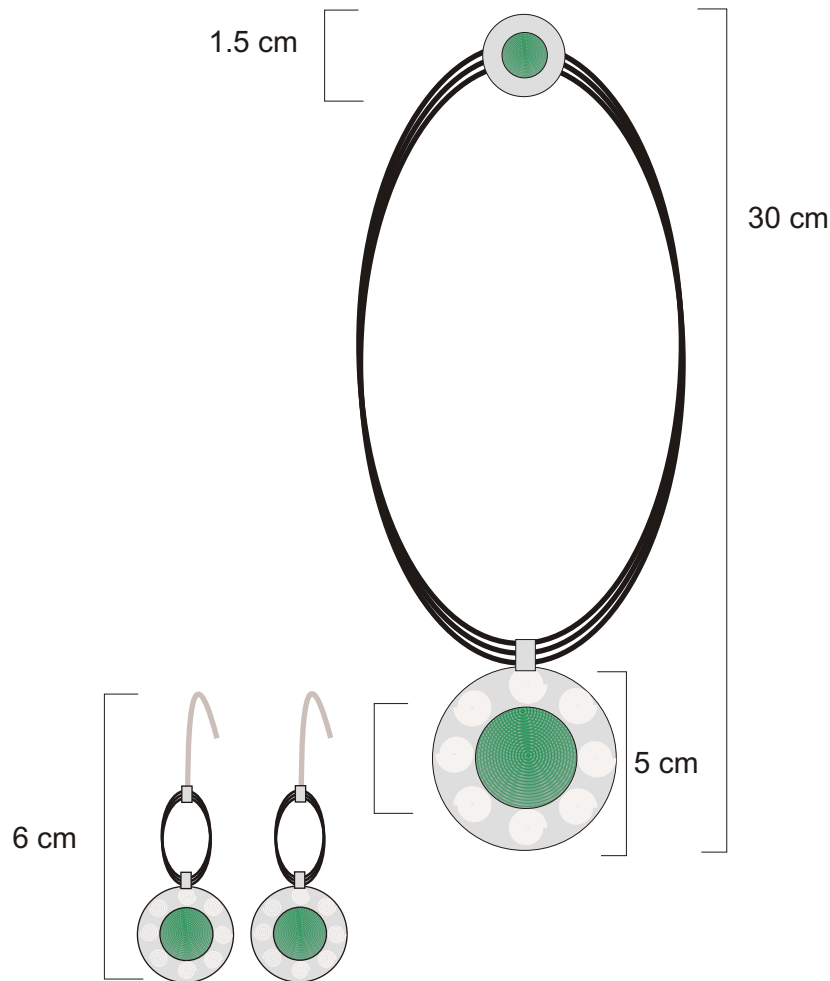

provócate  
DE CUNDINAMARCA

Producto referente



Producto mejorado



**Unidad Productiva:** Amigos de Zipaquira

**Representante:** Ana Torres Velasquez

**Código:** 1577

**Categoría:** Accesorios de moda

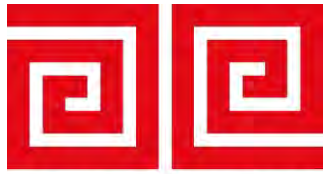

artesañas de colombia s.a.

Planos técnicos

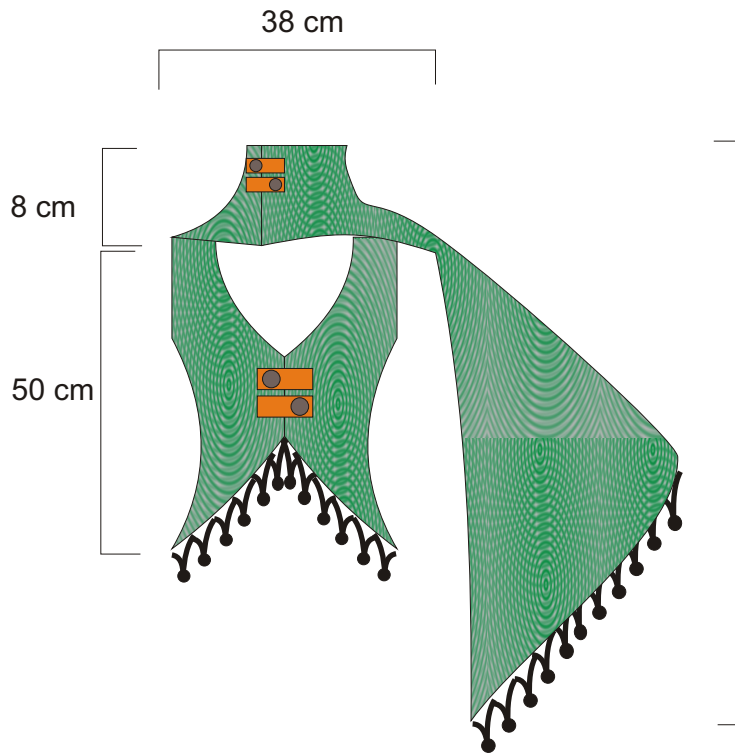

provócate  
DE CUNDINAMARCA

Producto referente



Producto mejorado

70 cm



Talla 10

**Unidad Productiva:** Neila Cano

**Representante:** Neila Cano

**Código:** 453

**Categoría:** Prendas de vestir



artesañas de colombia s.a.

Planos técnicos

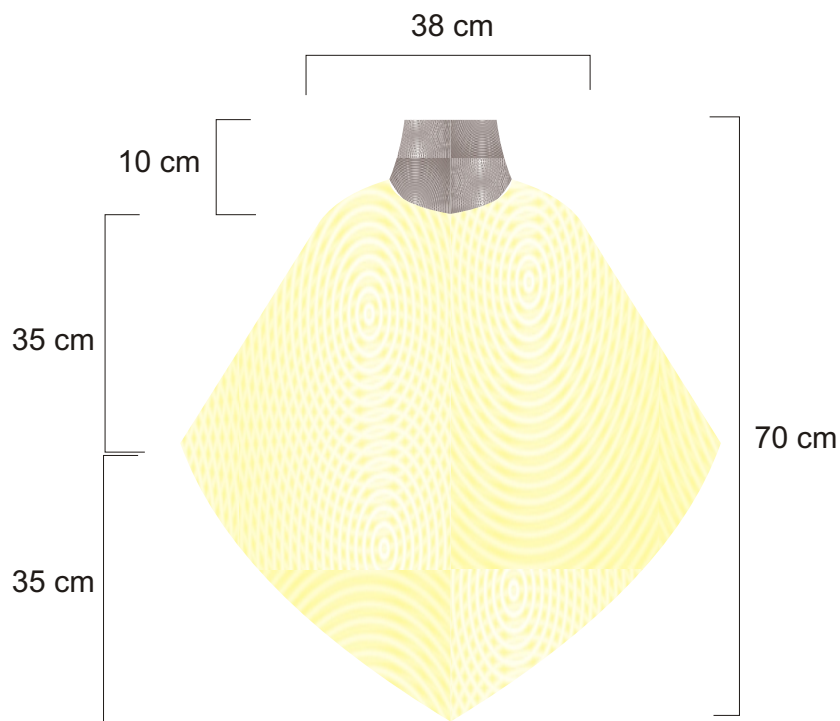

provócate  
DE CUNDINAMARCA

Producto referente



Producto mejorado



**Unidad Productiva:** Tejidos Aracné

**Representante:** Angela María Alarcón

**Código:** 1338

**Categoría:** Prendas de Vestir





artesanías de colombia s.a.

Planos técnicos

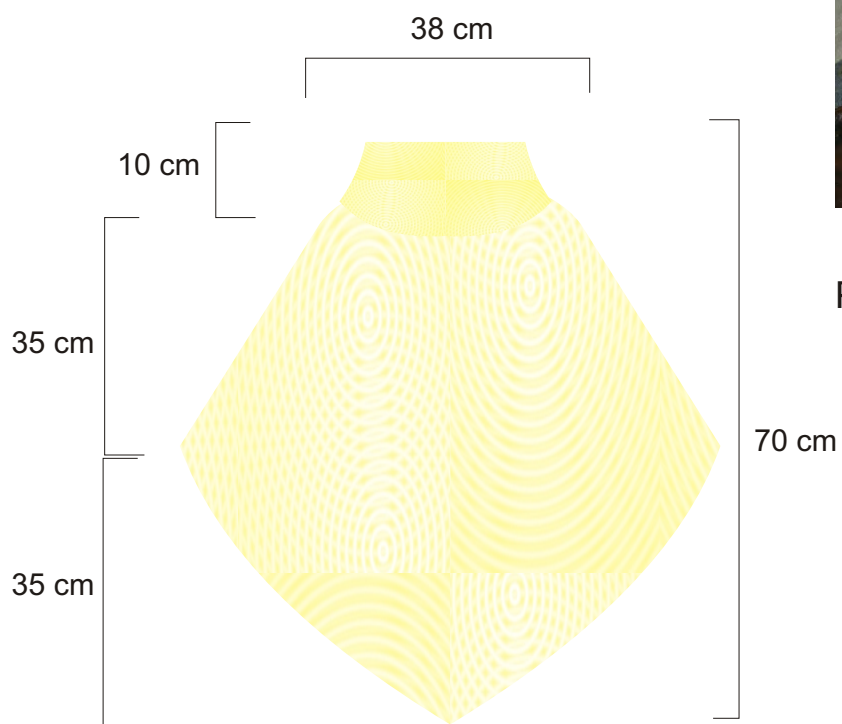

provócate  
DE CUNDINAMARCA

Producto referente



Producto mejorado



**Unidad Productiva: APUC**

**Representante:** María del Carmen Alarcón

**Código:** 3433

**Categoría:** Prendas de Vestir

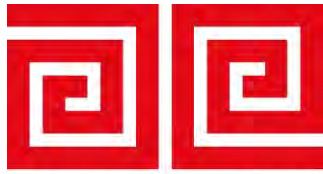

artesanías de colombia s.a.

Planos técnicos

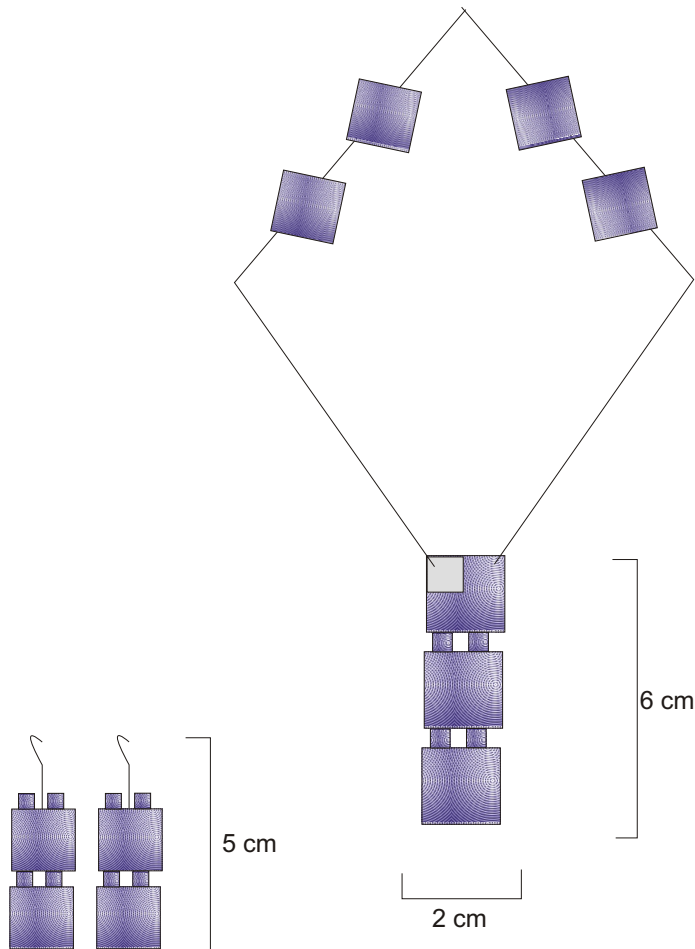

provócate  
DE CUNDINAMARCA

Producto referente



Producto mejorado

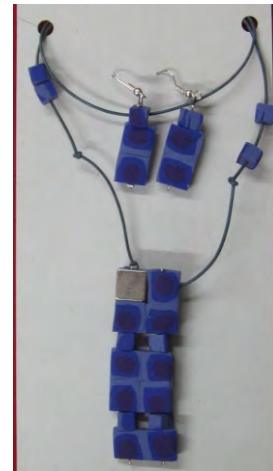

**Unidad Productiva:** Kamana

**Representante:** Gilda Ramos

**Código:** 3567

**Categoría:** Accesorios Moda



artesañas de colombia s.a.

Planos técnicos

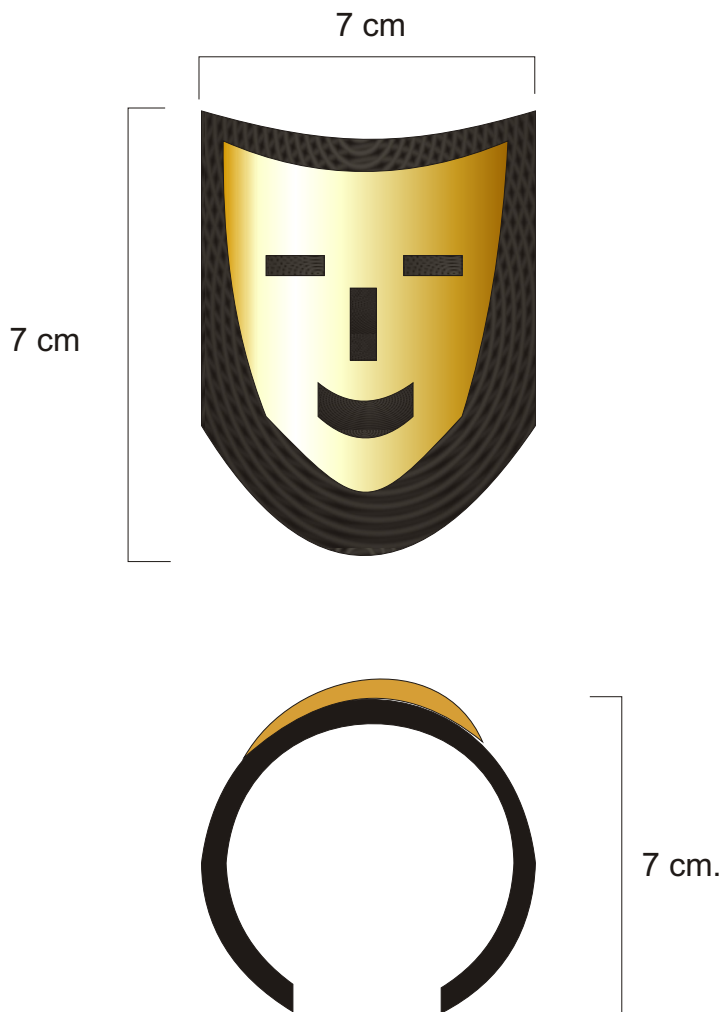

provócate  
DE CUNDINAMARCA

Producto referente



Producto mejorado



**Unidad Productiva:** Dipper Metal

**Representante:** Pedro Nel Castro

**Código:** 1860

**Categoría:** Accesorios Moda

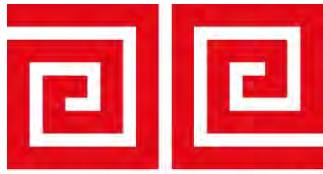

artesañas de colombia s.a.

Planos técnicos

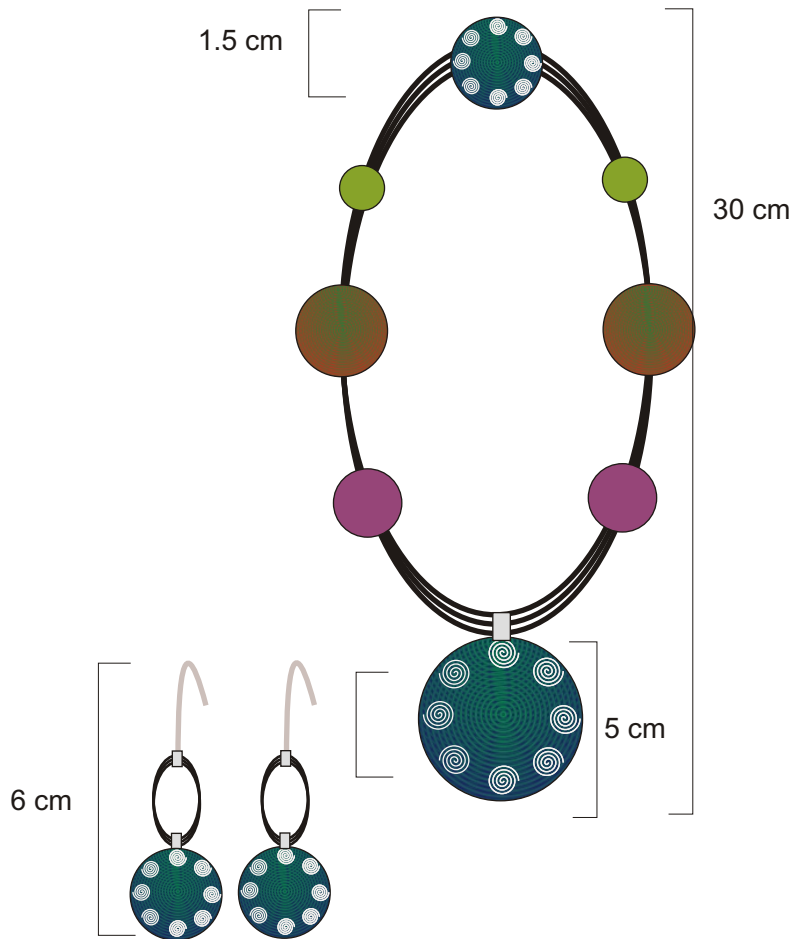

provócate  
DE CUNDINAMARCA

Producto referente



Producto mejorado



**Unidad Productiva:** Saju Semilla

**Representante:** Sandra Fonseca

**Código:** 3659

**Categoría:** Accesorios Moda

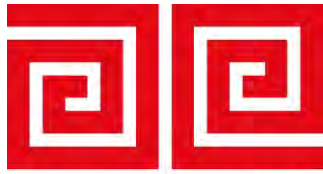

artesañas de colombia s.a.

Planos técnicos

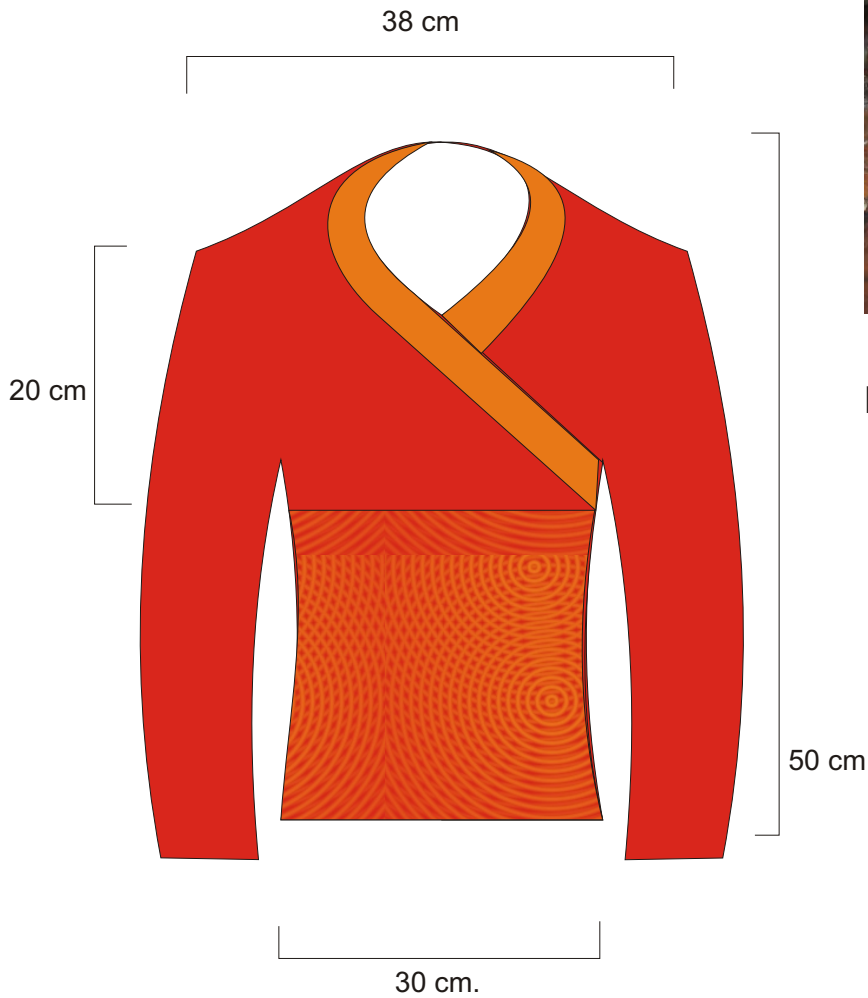

provócate  
DE CUNDINAMARCA

Producto referente



Producto mejorado



**Unidad Productiva:** APUC

**Representante:** Graciela Quiroga

**Código:** 2114

**Categoría:** Prendas de Vestir

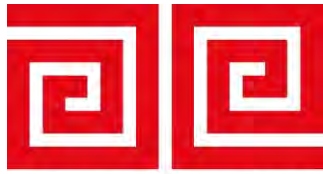

artesañas de colombia s.a.

Planos técnicos

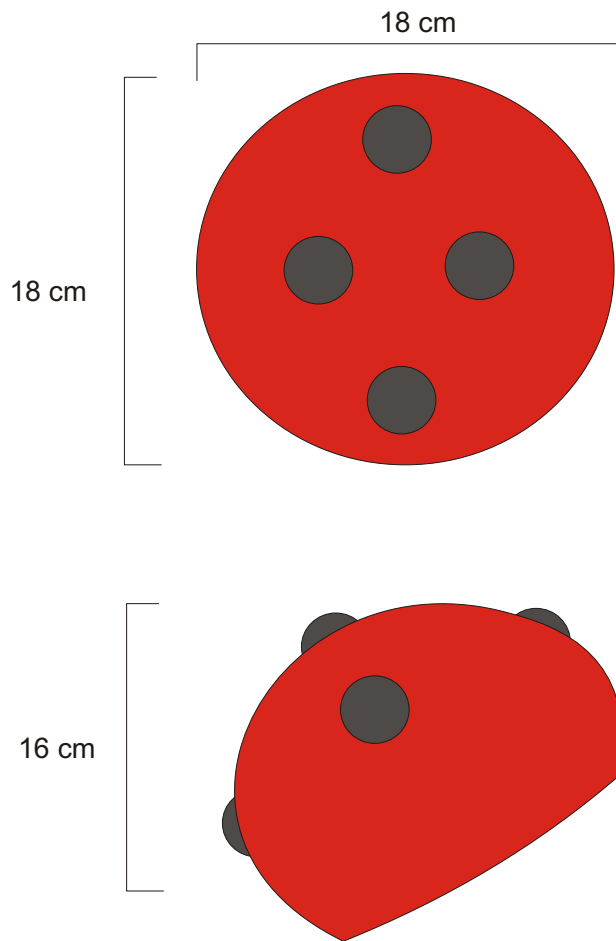

provócate  
DE CUNDINAMARCA

Producto referente



Producto mejorado



**Unidad Productiva:** Josefina Lancheros

**Representante:** Josefina Lancheros

**Código:** 2392

**Categoría:** Accesorios Moda

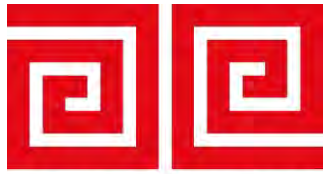

artesañas de colombia s.a.

Planos técnicos

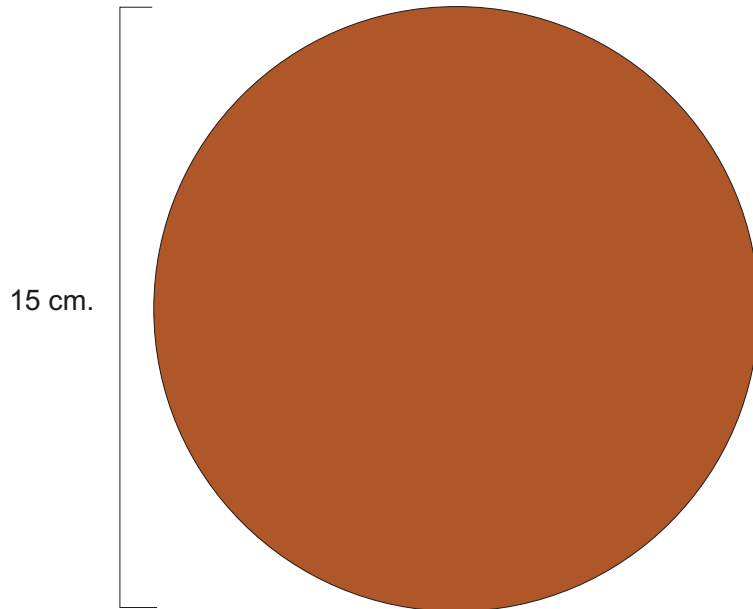

15 cm.

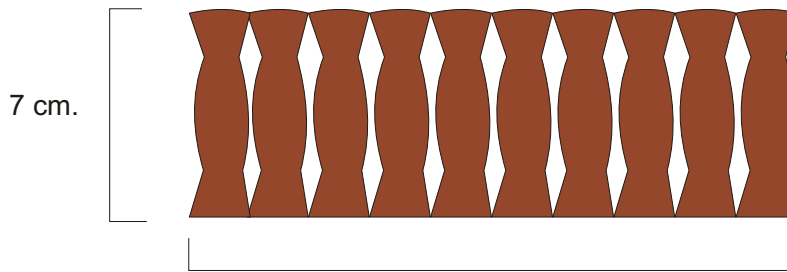

7 cm.

15 cm.



provócate  
DE CUNDINAMARCA

Producto referente



Producto mejorado



**Unidad Productiva:** Artesanías el Laurel

**Representante:** Dora Flor Alba Briceño

**Código:** 3375

**Categoría:** Mesa y Cocina, Hogar y decoración

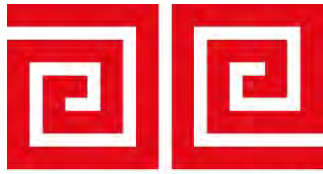

artesañas de colombia s.a.

Planos técnicos

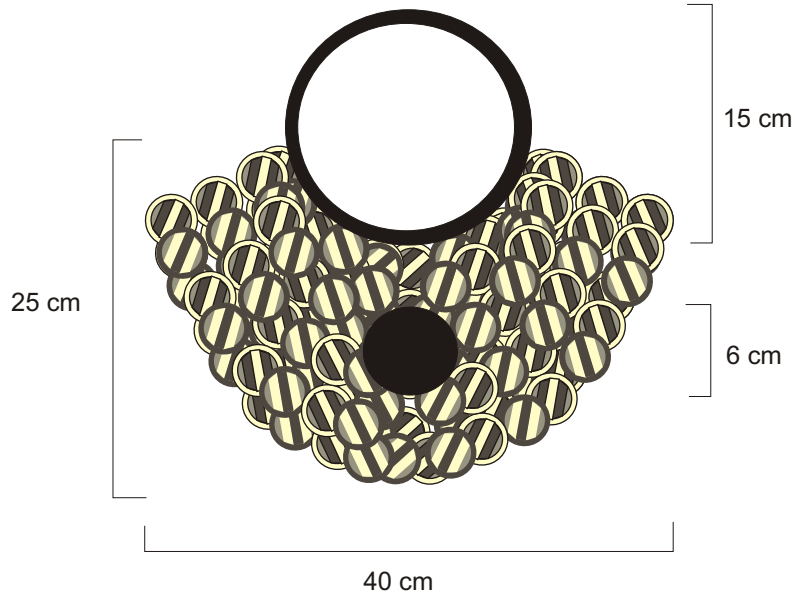

provócate  
DE CUNDINAMARCA

Producto referente



Producto mejorado



**Unidad Productiva:** Macramé In

**Representante:** William Cervantes

**Código:** 1512

**Categoría:** Accesorios moda



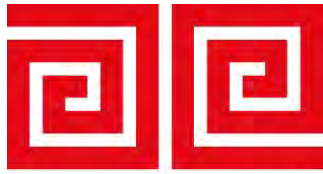

artesañas de colombia s.a.

Planos técnicos

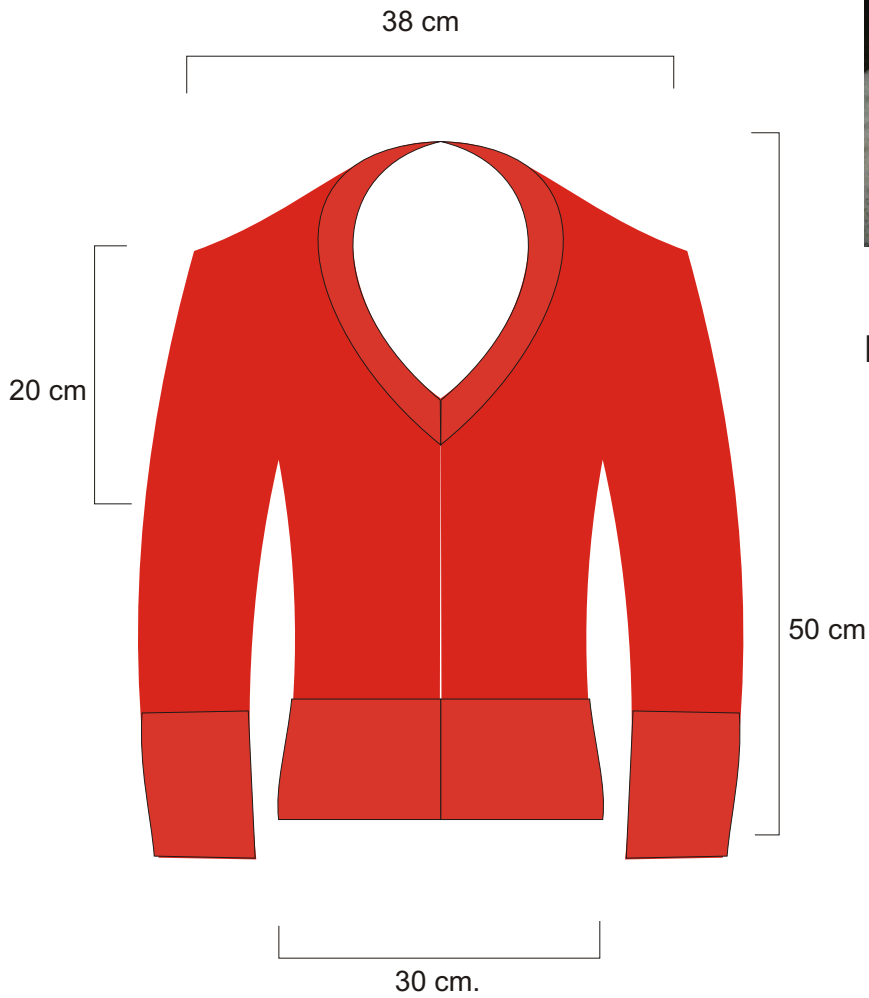

provócate  
DE CUNDINAMARCA

Producto referente



Producto mejorado



**Unidad Productiva:** Julianita

**Representante:** Julia Alarcón

**Código:** 2385

**Categoría:** Prendas de Vestir

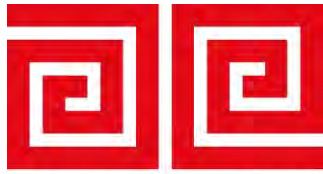

artesañas de colombia s.a.

Planos técnicos

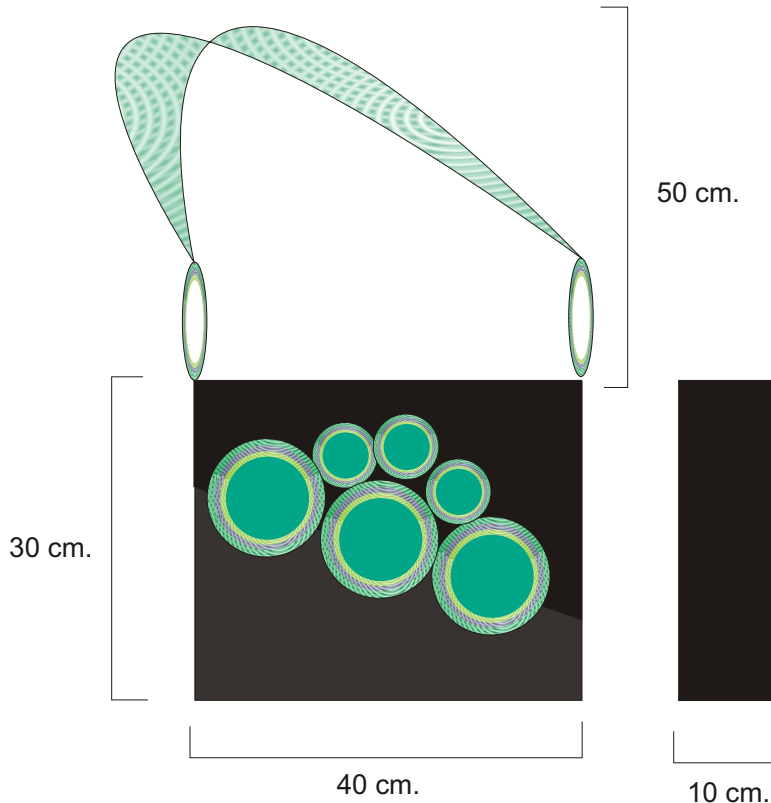

provócate  
DE CUNDINAMARCA

Producto referente



Producto mejorado

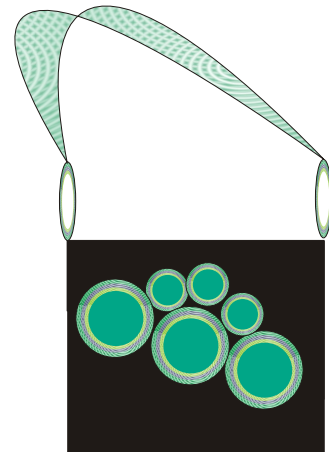

**Unidad Productiva: Fusión**

**Representante:** Daisy Quintana

**Código:** 4023

**Categoría:** Accesorios moda

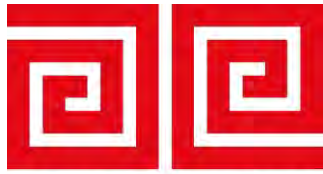

artesanías de colombia s.a.

Planos técnicos

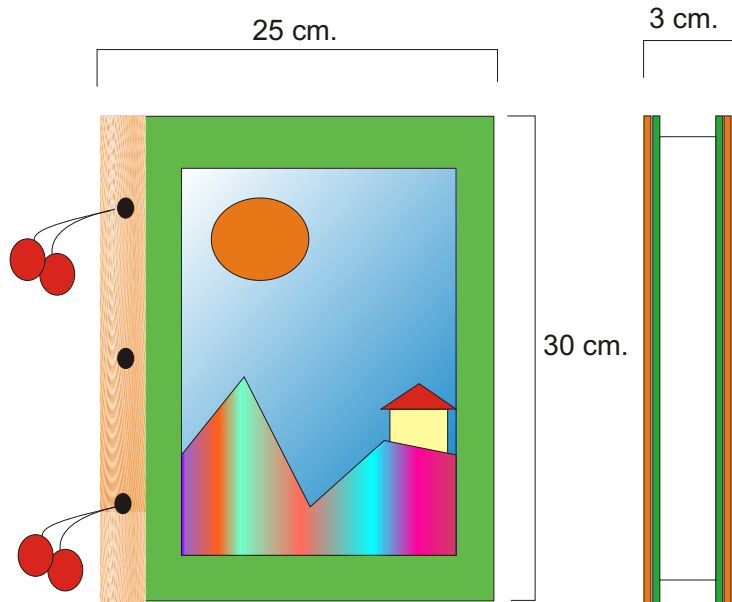

provócate  
DE CUNDINAMARCA

Producto referente



Producto mejorado

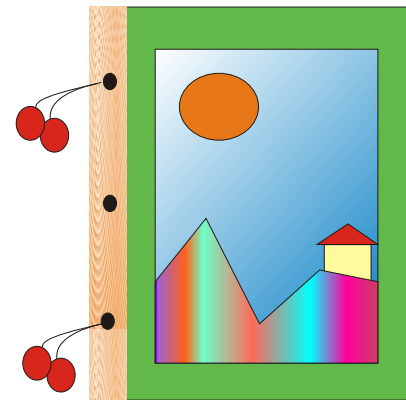

**Unidad Productiva: Ecoartes**

**Representante:** Olga Galindo

**Código:** 855

**Categoría:** mesa y cocina, hogar y decoración

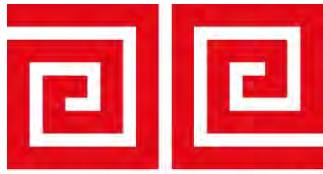

artesañas de colombia s.a.

Planos técnicos

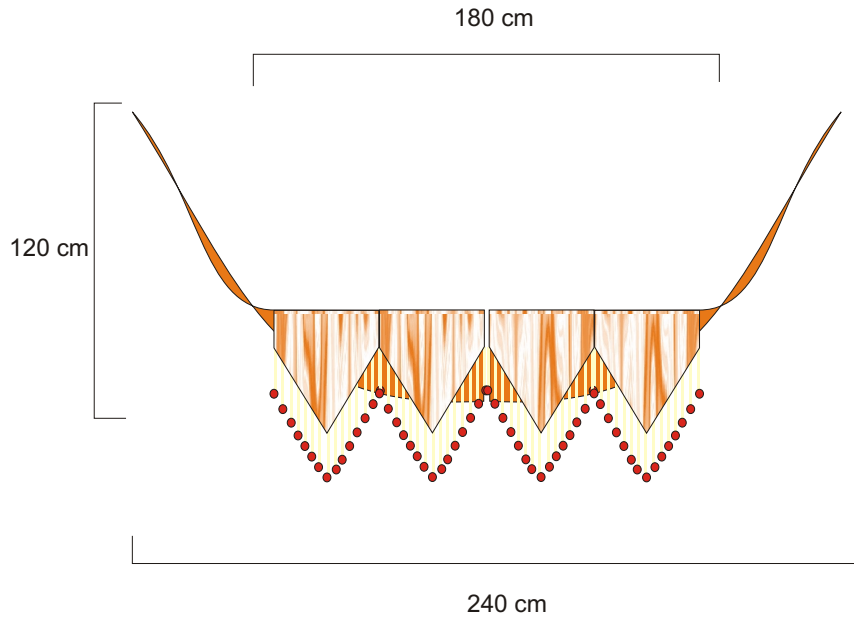

provócate  
DE CUNDINAMARCA

Producto referente



Producto mejorado



**Unidad Productiva:** El Taller de Laura

**Representante:** Laura Rozo Escobar

**Código:** 1331

**Categoría:** mesa y cocina, hogar y decoración

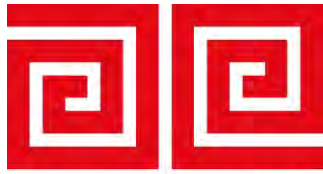

artesañas de colombia s.a.

Planos técnicos



provócate  
DE CUNDINAMARCA

Producto referente



Producto mejorado



**Unidad Productiva:** Expresión Tenjana

**Representante:** María Edilma Palacios

**Código:** 3978

**Categoría:** Prendas de Vestir

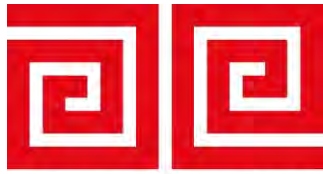

artesañas de colombia s.a.

Planos técnicos

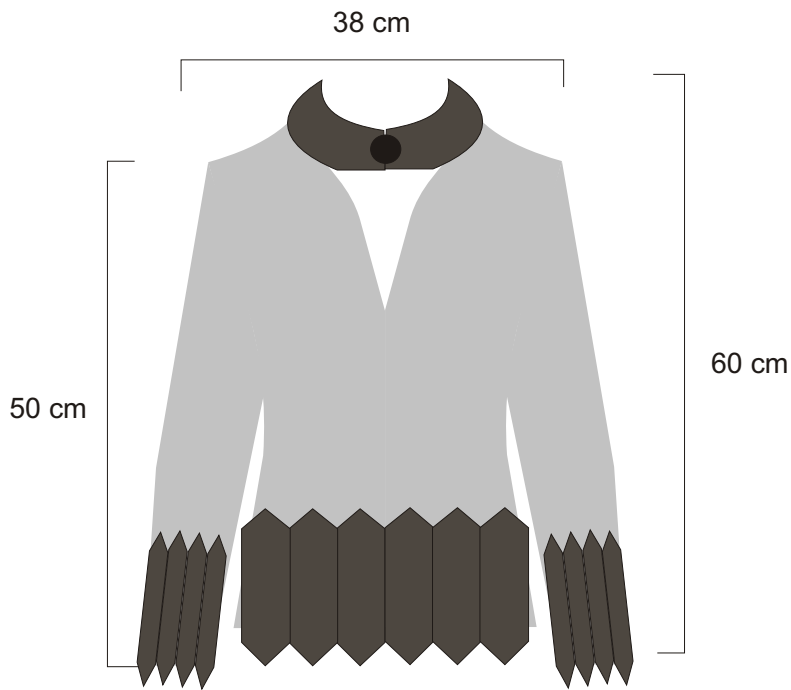

provócate  
DE CUNDINAMARCA

Producto referente



Producto mejorado



**Unidad Productiva:** APUC  
**Representante:** María Antonia González  
**Código:** 640  
**Categoría:** Prendas de Vestir

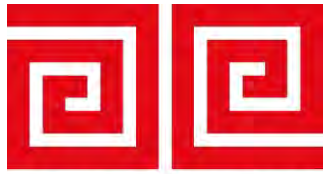

artesañas de colombia s.a.

Planos técnicos

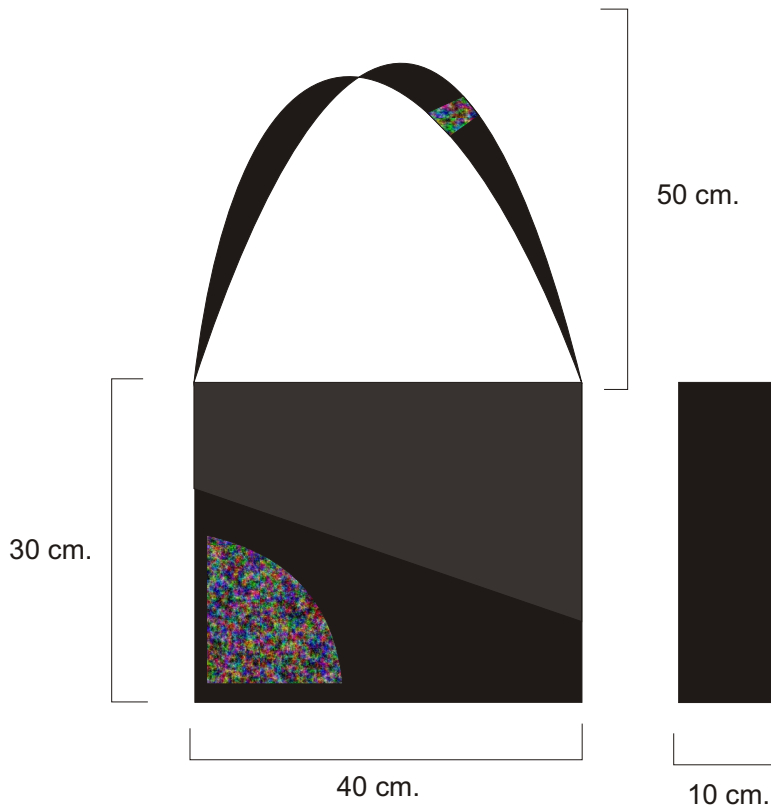

provócate  
DE CUNDINAMARCA

Producto referente



Producto mejorado



**Unidad Productiva:** Jenny Salas

**Representante:** Jenny Salas

**Código:** 1129

**Categoría:** Accesorios Moda



artesañas de colombia s.a.

Planos técnicos

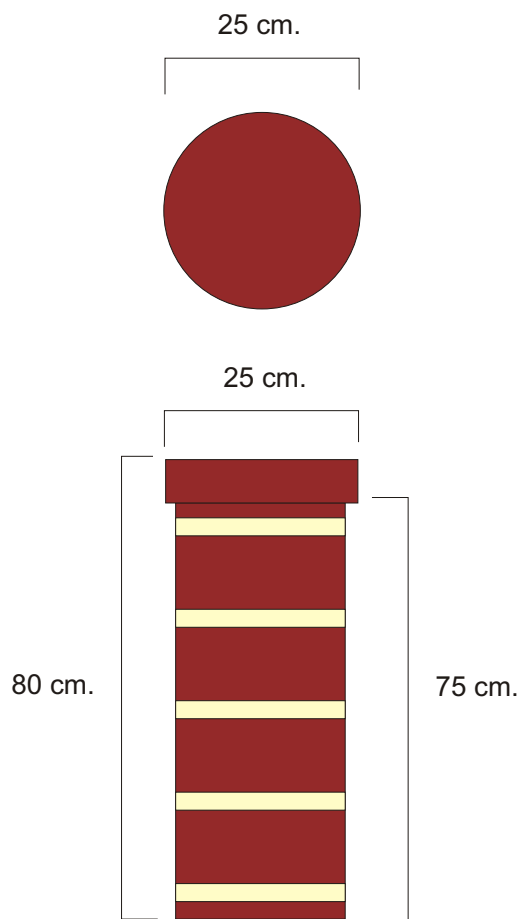

provócate  
DE CUNDINAMARCA

Producto referente



Producto mejorado



**Unidad Productiva:** Arte y Mimbre

**Representante:** Arte y Mimbre

**Código:** 3168

**Categoría:** Mesa, Cocina, hogar y Decoración



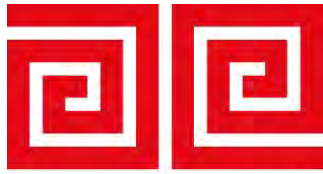

artesanías de colombia s.a.

Planos técnicos

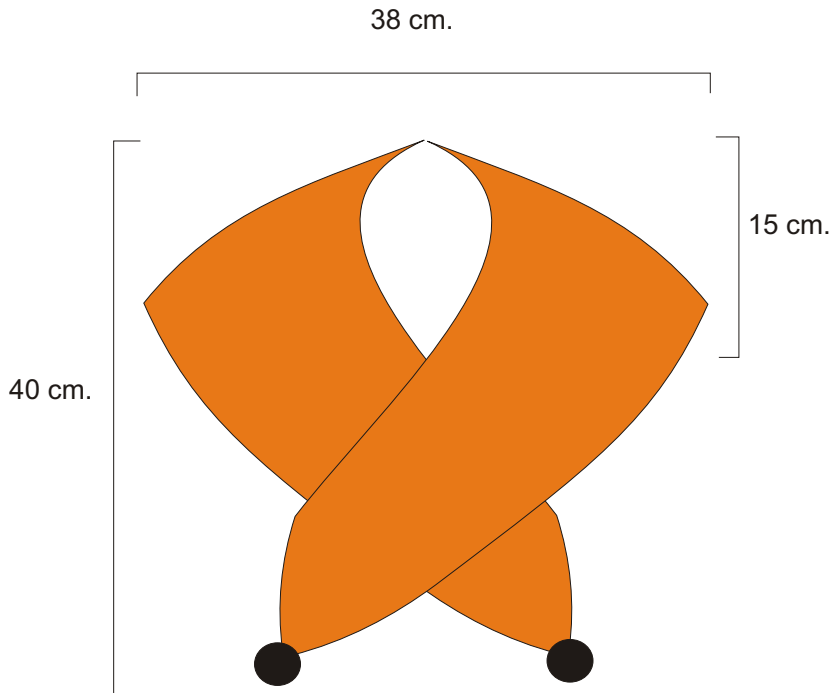

provócate  
DE CUNDINAMARCA

Producto referente



Producto mejorado



**Unidad Productiva:** María Pachón

**Representante:** María Pachón

**Código:** 431

**Categoría:** Prendas de Vestir

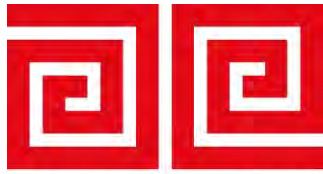

artesanías de colombia s.a.

Planos técnicos



provócate  
DE CUNDINAMARCA

Producto referente



Producto mejorado

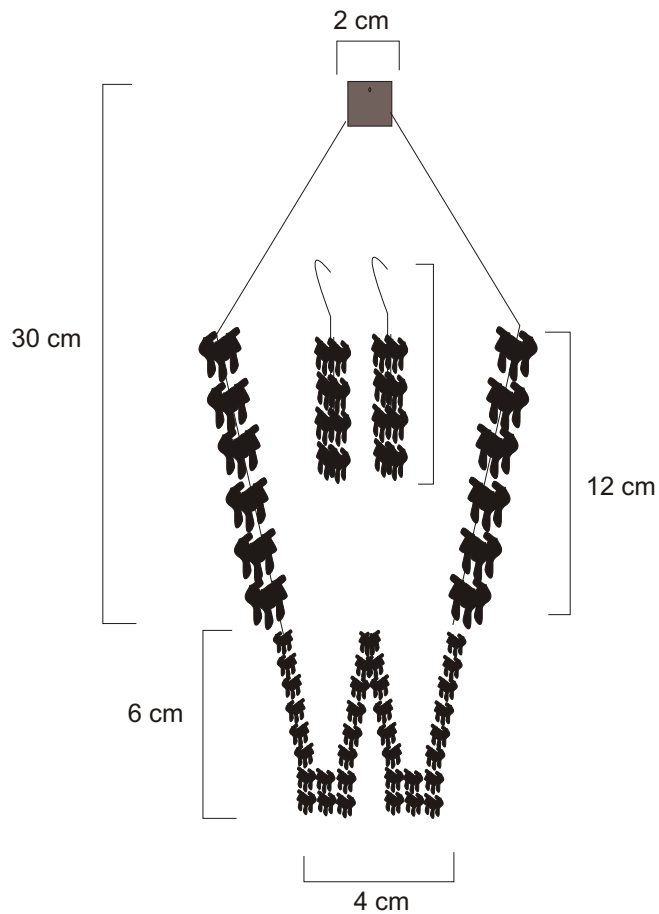

**Unidad Productiva:** Luz Marina Barón

**Representante:** Luz Marina Barón

**Código:** 1429

**Categoría:** Accesorios de Moda

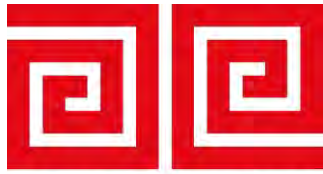

artesañas de colombia s.a.

Planos técnicos



25 cm.



provócate  
DE CUNDINAMARCA

Producto referente



Producto mejorado



**Unidad Productiva:** Olga Avila

**Representante:** Olga Avila

**Código:** 931

**Categoría:** Mesa, Cocina, Hogar y decoración

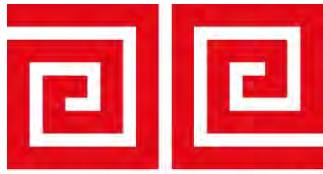

artesañas de colombia s.a.

Planos técnicos

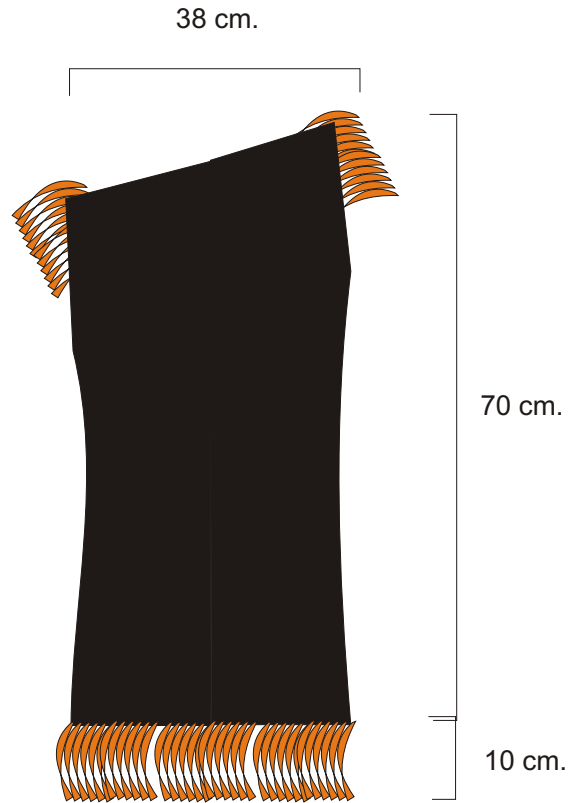

provócate  
DE CUNDINAMARCA

Producto referente



Producto mejorado



**Unidad Productiva:** APUC

**Representante:** Luz Marina Arévalo

**Código:** 2115

**Categoría:** Prendas de Vestir



artesañas de colombia s.a.

Planos técnicos

38 cm.

60 cm.



provócate  
DE CUNDINAMARCA

Producto referente



Producto mejorado

50 cm.



**Unidad Productiva:** APUC  
**Representante:** María Ester Castañeda  
**Código:** 432  
**Categoría:** Prendas de Vestir

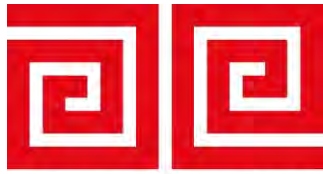

artesanías de colombia s.a.

Planos técnicos

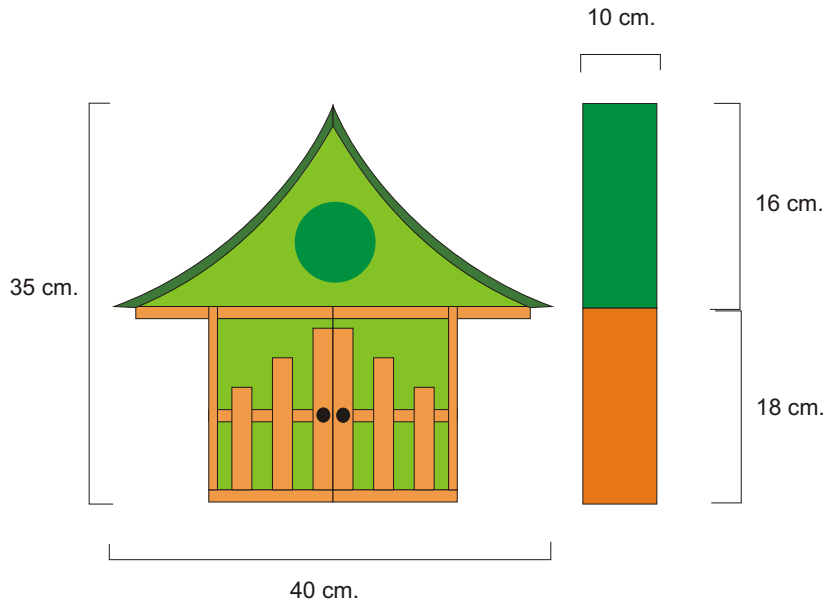

provócate  
DE CUNDINAMARCA

Producto referente



Producto mejorado

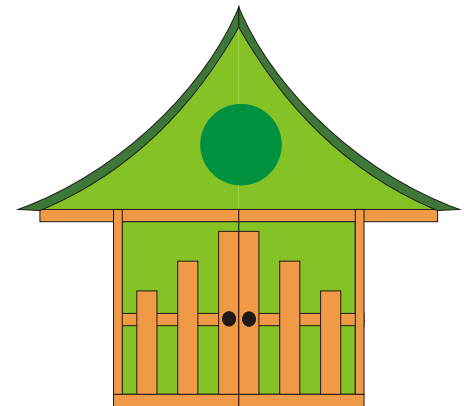

**Unidad Productiva:** Jorge Velazco

**Representante:** Jorge Velazco

**Código:** 1008

**Categoría:** Mesa, Cocina, Hogar y decoración



artesañas de colombia s.a.

Planos técnicos



provócate  
DE CUNDINAMARCA

Producto referente



Producto mejorado

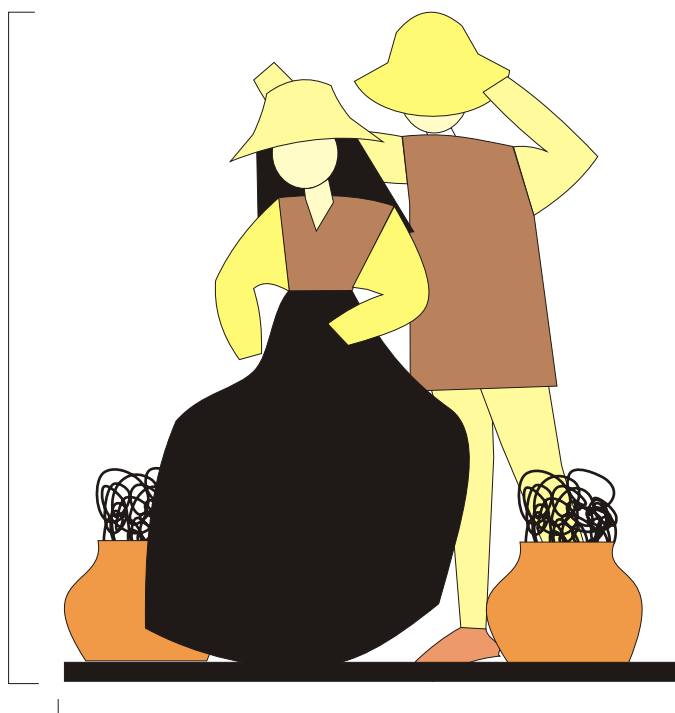

20 cm.

**Unidad Productiva:** Artesanos Unidos

**Representante:** María del Tránsito Pérez

**Código:** 2656

**Categoría:** Mesa, Cocina, Hogar y decoración

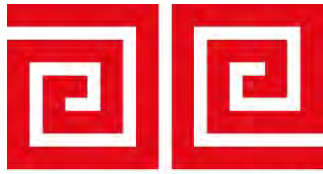

artesañas de colombia s.a.

Planos técnicos

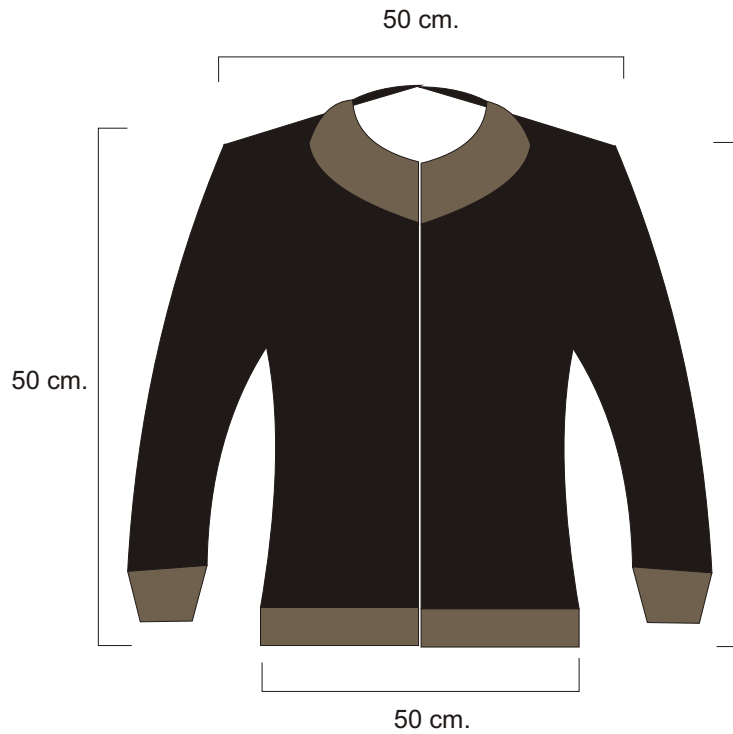

provócate  
DE CUNDINAMARCA

Producto referente



Producto mejorado



**Unidad Productiva:** APUC  
**Representante:** Margarita Rubiano Veloza  
**Código:** 626  
**Categoría:** Prendas de Vestir



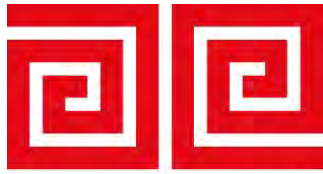

artesañas de colombia s.a.

Planos técnicos

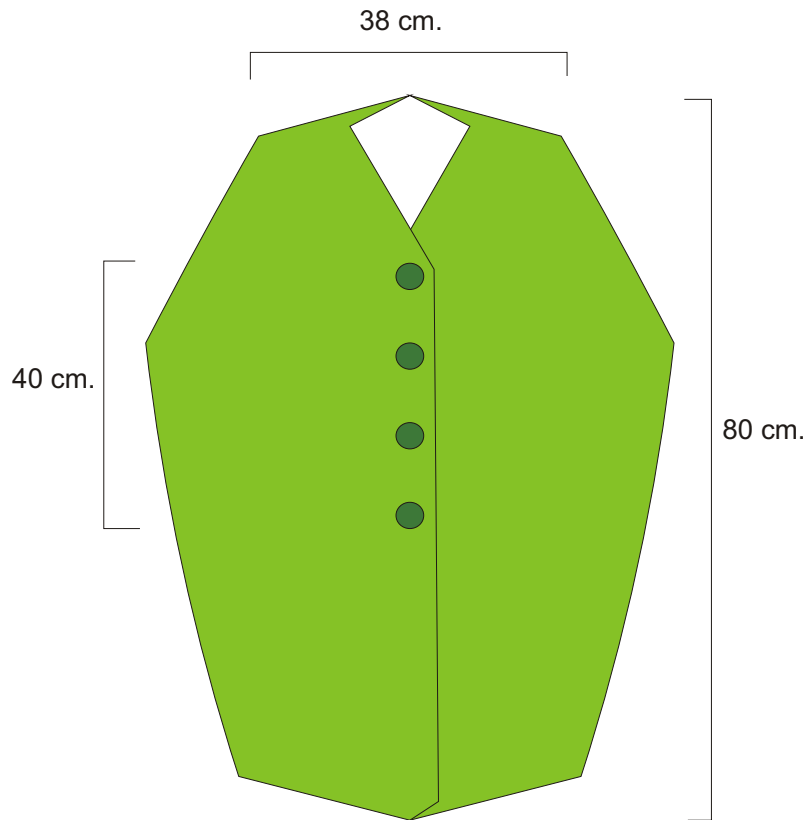

provócate  
DE CUNDINAMARCA

Producto referente



Producto mejorado



**Unidad Productiva:** APUC

**Representante:** Aracely Alarcón

**Código:** 450

**Categoría:** Prendas de Vestir



artesanías de colombia s.a.

Planos técnicos

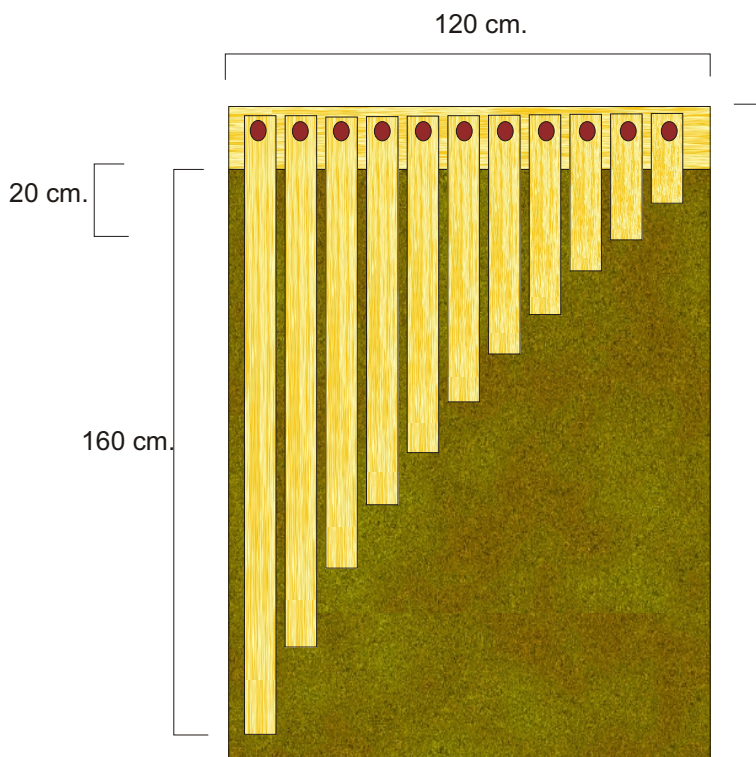

provócate  
DE CUNDINAMARCA

Producto referente

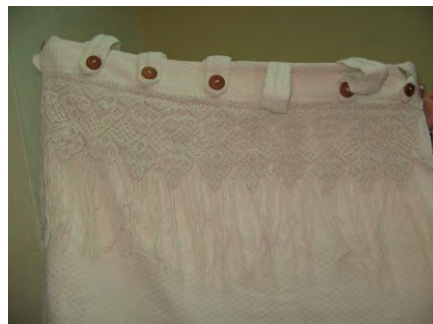

Producto mejorado

180 cm.



**Unidad Productiva: Doris Espitia**

**Representante:** Doris Espitia

**Código:** 1340

**Categoría:** Mesa, Cocina, Hogar y decoración